



ROHDE & SCHWARZ

Instruments
Division

Operating Manual

SIGNAL GENERATOR

SMHU

0.1 to 4320 MHz

835.8011.52/.56/.58

Printed in the Federal
Republic of Germany

Certified Quality System ISO 9001

DQS REG. NO 1954-02

Qualitätszertifikat

Sehr geehrter Kunde,

Sie haben sich für den Kauf eines Rohde & Schwarz-Produktes entschieden. Hiermit erhalten Sie ein nach modernsten Fertigungsmethoden hergestelltes Produkt. Es wurde nach den Regeln unseres Qualitätsmanagementsystems entwickelt, gefertigt und geprüft. Das Rohde & Schwarz-Qualitätsmanagementsystem ist nach ISO 9001 zertifiziert.

Certificate of quality

Dear Customer,

You have decided to buy a Rohde & Schwarz product. You are thus assured of receiving a product that is manufactured using the most modern methods available. This product was developed, manufactured and tested in compliance with our quality management system standards.

The Rohde & Schwarz quality management system is certified according to ISO 9001.

Certificat de qualité

Cher client,

Vous avez choisi d'acheter un produit Rohde & Schwarz. Vous disposez donc d'un produit fabriqué d'après les méthodes les plus avancées. Le développement, la fabrication et les tests respectent nos normes de gestion qualité.

Le système de gestion qualité de Rohde & Schwarz a été homologué conformément à la norme ISO 9001.



ROHDE & SCHWARZ



ROHDE & SCHWARZ

EC Certificate of Conformity

(to EMC Directive 89/336/EEC)

CE

This is to certify that

Signalgenerator

SMHU

0835.8011.50 / .52 / .56 / .58

(equipment, type, designation)

complies with the provisions of the Directive of the Council of the European Communities on the approximation of the laws of the Member States relating to electromagnetic compatibility (EMC Directive 89/336/EEC).

This declaration of conformity of the European Communities is the result of an examination carried out by the quality assurance of **ROHDE & SCHWARZ** in accordance with European Standards EN 50081-1 and EN 50082-1, as laid down in Article 10 of the Directive.

ROHDE & SCHWARZ
GmbH & Co. KG

Contents

	Page
1	Technical Specifications (Data Sheet)
2	Preparations for Use and Operating Instructions 2.1
2.1	Legend to Front and Rear Panel Views 2.1
2.2	Preparations for Use 2.10
2.2.1	Power Fuse 2.10
2.2.2	Power Supply 2.10
2.2.3	Rack Mounting 2.10
2.3	Operating Instructions 2.11
2.3.1	Switch-on Status 2.17
2.3.2	Internal/External Reference Frequency 2.17
2.3.3	Frequency (RF) 2.19
2.3.4	Frequency Offset (RF OFFSET) 2.19
2.3.5	RF Level (LEV RF) 2.21
2.3.6	Level Offset (LEV OFFSET) 2.22
2.3.7	Transient-free Level Settings 2.23
2.3.8	Level emf 2.23
2.3.9	AGC off 2.24
2.3.10	Resetting Overvoltage Protection 2.24
2.3.11	Internal AF Modulation Frequency 2.25
2.3.12	AF Signal 2.27
2.3.13	AF Level (LEV AF) 2.28
2.3.14	Modulation, AM 2.29
2.3.15	Modulation, Broadband-AM (BB-AM), (only with SMHU .58) 2.31
2.3.16	Modulation, FM 2.32
2.3.17	Modulation, Broadband-FM (BB-FM), (only with SMHU .58) 2.34
2.3.18	Modulation, Φ M 2.36
2.3.19	Modulation, FM Pre-emphasis (FM PRE) 2.38
2.3.20	Modulation, FSK 2.39

	Page
2.3.21	Modulation, AM Square (AM SQU) 2.40
2.3.22	Modulation, PULSE 2.41
2.3.23	Modulation, I/Q (only with SMHU .58) 2.42
2.3.24	I/Q-Impairment (CARR LEAK, I><Q, QUAD OFFSET), (only with SMHU .58) 2.43
2.3.25	Modulation, GMSK (Option GMSK Coder) 2.46
2.3.26	Modulation, GFSK (Option DECT Coder) 2.49
2.3.27	Modulation, $\pi/4$ DQPSK (Option ADC Coder) 2.51
2.3.28	Modulation, $\pi/4$ DQPSK (Option CT Coder) 2.54
2.3.29	Modulation, External Source 2.57
2.3.30	Modulation, Two-tone 2.58
2.3.31	Rotary Knob Variation 2.59
2.3.32	Rotary Knob Variation, Step Size 2.60
2.3.33	Variation, HOLD 2.61
2.3.34	Variation, Δ REF 2.61
2.3.35	Variation, STEP 2.62
2.3.36	Heterodyne Band 125 MHz 2.63
2.3.37	Sweep 2.64
2.3.38	Sweep, RF 2.65
2.3.39	Sweep, AF 2.66
2.3.40	Sweep, LEV RF 2.67
2.3.41	Sweep, Memory (MEM) 2.68
2.3.42	Sweep, Fast Mode Memory 2.69
2.3.43	Fast Hop Bus (SMHU .56/58 only) 2.71
2.3.44	Sweep Parameter Entry 2.74
2.3.45	Sweep Operating Modes 2.75
2.3.46	Sweep, Start-Stop (LIN, LOG) 2.76
2.3.47	Sweep, Span 2.77
2.3.48	Sweep, Marker 2.78
2.3.49	Sweep Outputs 2.79
2.3.50	Phase Offset 2.80
2.3.51	External Trigger 2.81
2.3.52	Store - Recall 2.82
2.3.53	Special Functions 2.83
2.3.54	Self-test 2.88
2.3.55	Status 2.88
2.3.56	Preset 2.91
2.3.57	IEC Bus Address 2.92

	Page
2.4	Remote Control of the SMHU Signal Generator via IEC Bus 2.93
2.4.1	Brief Instructions for Simple Applications 2.93
2.4.2	Setting the Device Address 2.93
2.4.3	Device Messages 2.94
2.4.3.1	Device-specific Setting Commands 2.95
2.4.3.2	Device-specific Data Request Commands and Messages Sent by the SMHU 2.103
2.4.3.3	Common, Device-independent Setting Commands (Common Commands) 2.108
2.4.3.4	Common, Device-independent Data Request Commands (Common Queries) 2.109
2.4.3.5	Examples 2.110
2.4.3.6	Syntax of Setting Commands and Data Request Commands 2.112
2.4.3.7	Data Request and Syntax of Messages Sent by the SMHU in Talker Mode to the Controller 2.115
2.4.3.8	Alternative Commands and Notations 2.117
2.4.4	Interface Messages 2.118
2.4.4.1	Universal Commands 2.118
2.4.4.2	Addressed Commands 2.118
2.4.5	Service Request and Status Registers 2.120
2.4.6	Command Processing Sequence and Synchronization 2.126
2.4.7	Error Handling 2.127
2.4.8	Resetting of Device Functions 2.127
2.4.9	Local/Remote Switchover 2.128
2.4.10	Interface Functions 2.128
2.4.11	IEC Bus Connector and Bus Lines 2.129
2.5	Fitting the Options 2.130

	Page
3	Maintenance 3.1
3.1	Required Equipment 3.1
3.2	Testing the Rated Specifications 3.3
3.2.1	Displays and Keyboard 3.3
3.2.2	Frequency Setting 3.3
3.2.3	Settling Time 3.3
3.2.4	Reference Frequency 3.4
3.2.5	Harmonic and Subharmonic Spurious 3.4
3.2.6	Nonharmonic Spurious 3.4
3.2.7	SSB Phase Noise 3.5
3.2.8	Broadband Noise 3.6
3.2.9	Residual FM 3.6
3.2.10	Residual AM 3.6
3.2.11	Output Level 3.7
3.2.12	Calibrated Attenuator 3.7
3.2.13	Output Reflection Coefficient 3.7
3.2.14	Transient-free Level Settings 3.8
3.2.15	Overvoltage Protection 3.9
3.2.16	AF Generator 3.9
3.2.17	Checking Level Monitoring at the External Modulation Inputs 3.9
3.2.18	AM Modulation Depth 3.9
3.2.19	AM Frequency Response 3.10
3.2.20	AM Distortion 3.10
3.2.21	AM DC 3.10
3.2.22	Incidental Φ M in AM mode 3.10
3.2.23	Digital AM (AM Square) 3.10
3.2.24	Pulse Modulation 3.11
3.2.25	FM Deviation Setting 3.11
3.2.26	FM Frequency Response 3.11
3.2.27	FM Distortion 3.11
3.2.28	FM Pre-emphasis 3.11
3.2.29	Incidental AM with FM 3.12
3.2.30	Frequency Deviation with FM 3.12
3.2.31	FSK Modulation 3.12
3.2.32	Φ M Deviation Setting 3.12
3.2.33	Φ M Frequency Response 3.12
3.2.34	Φ M Distortion 3.12

	Page
3.2.35	Harmonic Spuriae 3.13
3.2.36	Non-Harmonic Spuriae 3.13
3.2.37	SSB Phase Noise 3.14
3.2.38	Broadband Noise 3.14
3.2.39	BB-FM Deviation Accuracy 3.15
3.2.40	BB-FM Distortion 3.15
3.2.41	Residual FM with BB-FM / I/Q 3.16
3.2.42	BB-FM Frequency Response 3.16
3.2.43	Level Accuracy with BB-AM 3.17
3.2.44	BB-AM Modulation Depth 3.18
3.2.45	BB-AM Distortion 3.18
3.2.46	BB-AM Frequency Response 3.18
3.2.47	Testing the Carrier Leakage with I/Q Modulation 3.19
3.2.48	Testing the Vector DC Accuracy with I/Q Modulation 3.19
3.2.49	Testing the Modulation Bandwidth with I/Q Modulation 3.21
3.2.50	Testing the VSWR of the Modulation Inputs I and Q 3.21
3.2.51	Testing the I/Q Vector Imbalance 3.21
3.2.52	Testing the Data Rate with GMSK 3.22
3.2.53	Testing the Modulation Phase Error with GMSK 3.22
3.2.54	Testing the Spectrum with GMSK Modulation 3.23
3.2.55	Testing the Data Rate with DECT 3.23
3.2.56	Testing the Modulation Frequency Error with DECT 3.24
3.2.57	Testing the Spectrum with DECT Modulation 3.24
3.2.58	Testing the Data Rate with ADC/JDC 3.25
3.2.59	Testing the Modulation Error with ADC 3.25
3.2.60	Testing the Spectrum with ADC Modulation 3.26
3.2.61	Testing the Data Rate with CT 3.26
3.2.62	Testing the Modulation Error with CT 3.27
3.2.63	Testing the Spectrum with CT Modulation 3.27
3.3	Performance Test Report 3.28

2 Preparations for Use and Operating Instructions

All data given in this section are for simplified illustration only and not guaranteed. Binding technical data are those as specified in the enclosed Data Sheet

All figures printed *boldfaced and in italics* refer to the front and rear panel views of Fig 2-1 and Fig. 2-2

2.1 Legend to Front and Rear Panel Views

Front panel view

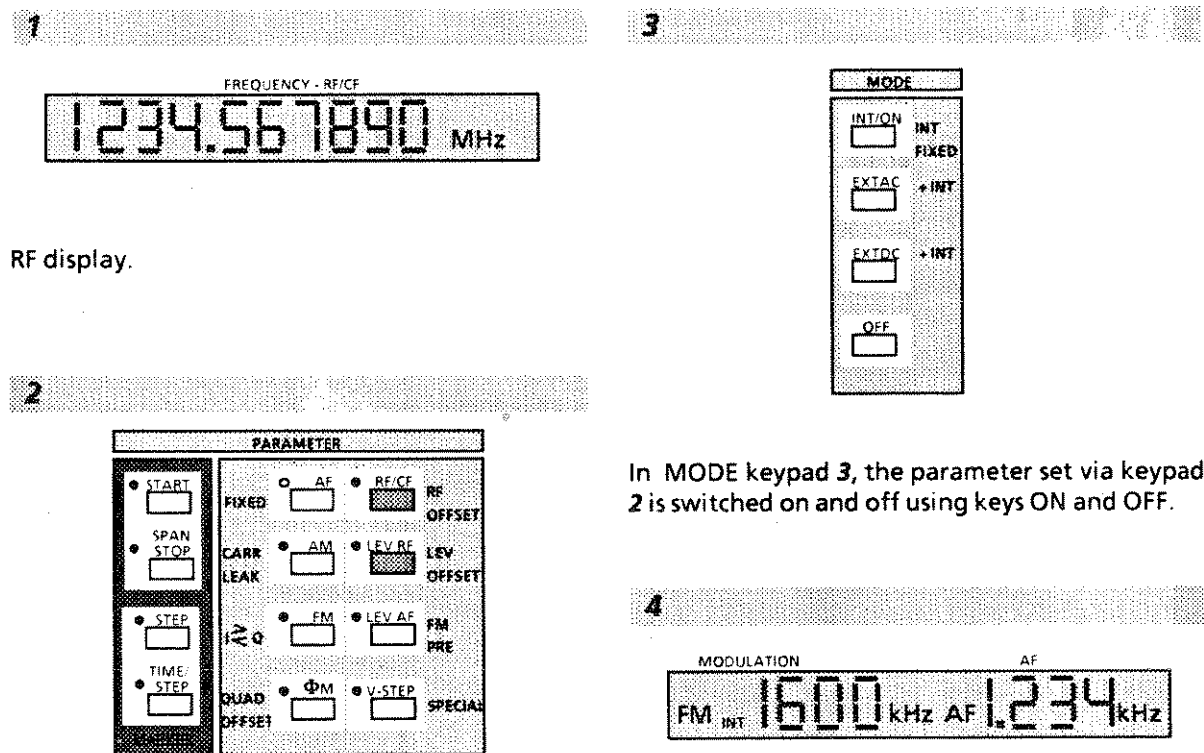

PARAMETER keypad **2** used for setting the parameter to which following numeric entries and variations apply.

Display of the modulation depth, deviation and AF. For further display functions, refer to section 2.3 on "Operating Instructions".

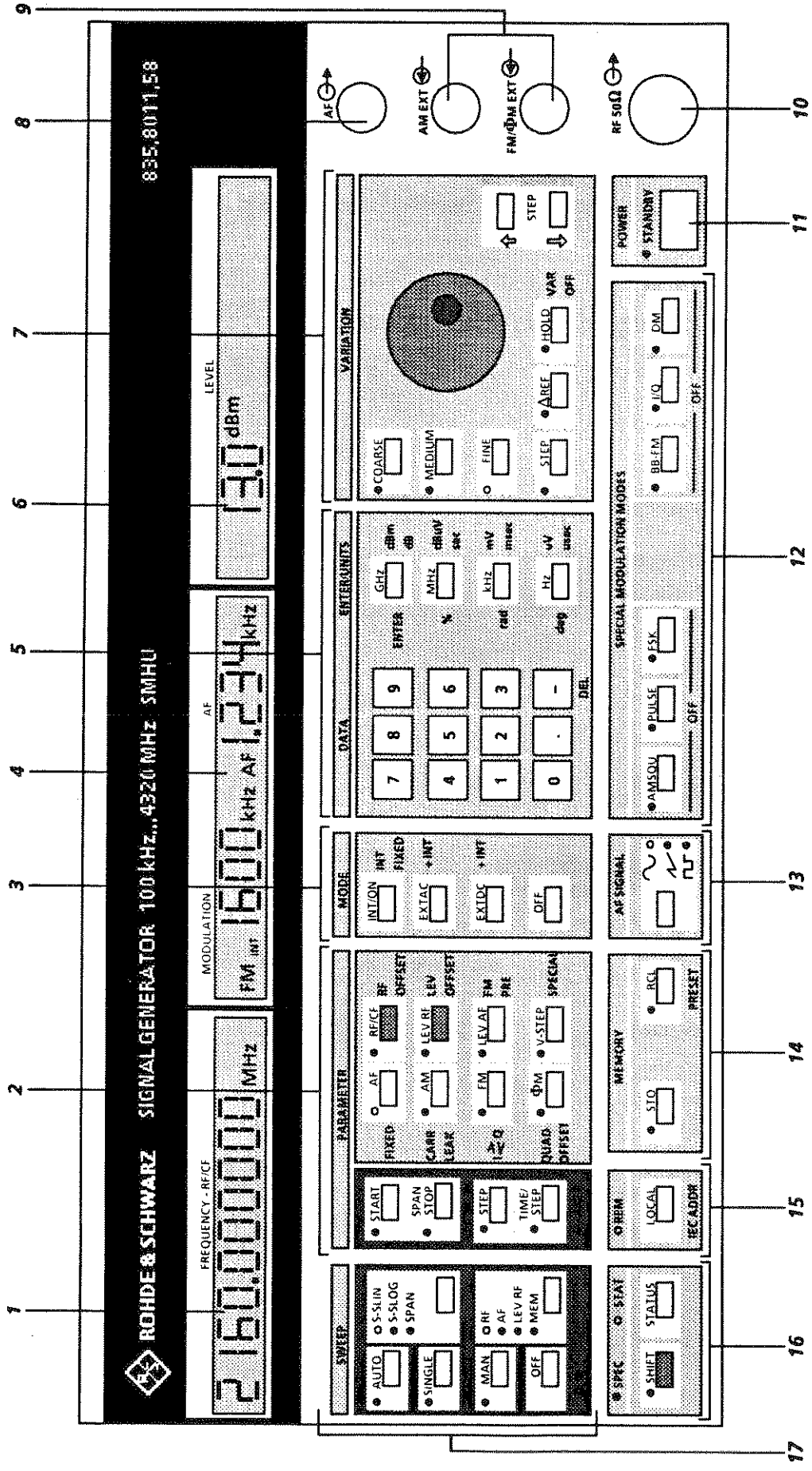
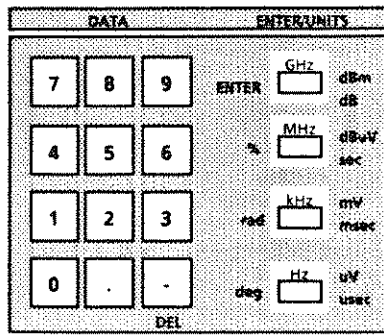

Fig. 2-1 Front panel view

5



Numeric keypad to enter the respective values for the parameter set in parameter keypad 2.

6

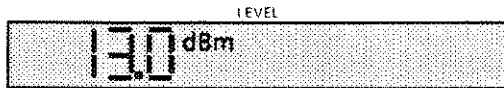

Display of RF or AF level. For further display functions, refer to section 2.3 on "Operating Instructions".

7

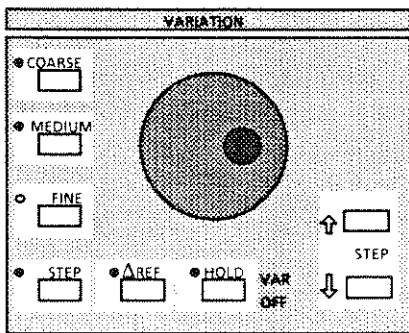

Keypad for variation of the parameter set in parameter keypad 2 using the rotary knob or STEP ↑ ↓ keys.

8

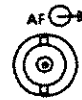

BNC output of internal AF signal. For further information, refer to sections on "Internal AF Modulation Frequency", "AF Signal" and "AF Level (LEV AF)".

9

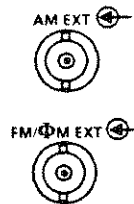

BNC inputs for external modulation signals. Input impedance 100 kΩ (600 Ω). For further information, refer to section on "Modulation, External Source".

10

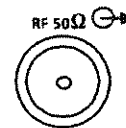

RF output, N socket 50 Ω.

11

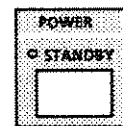

Standby-/ON switch.

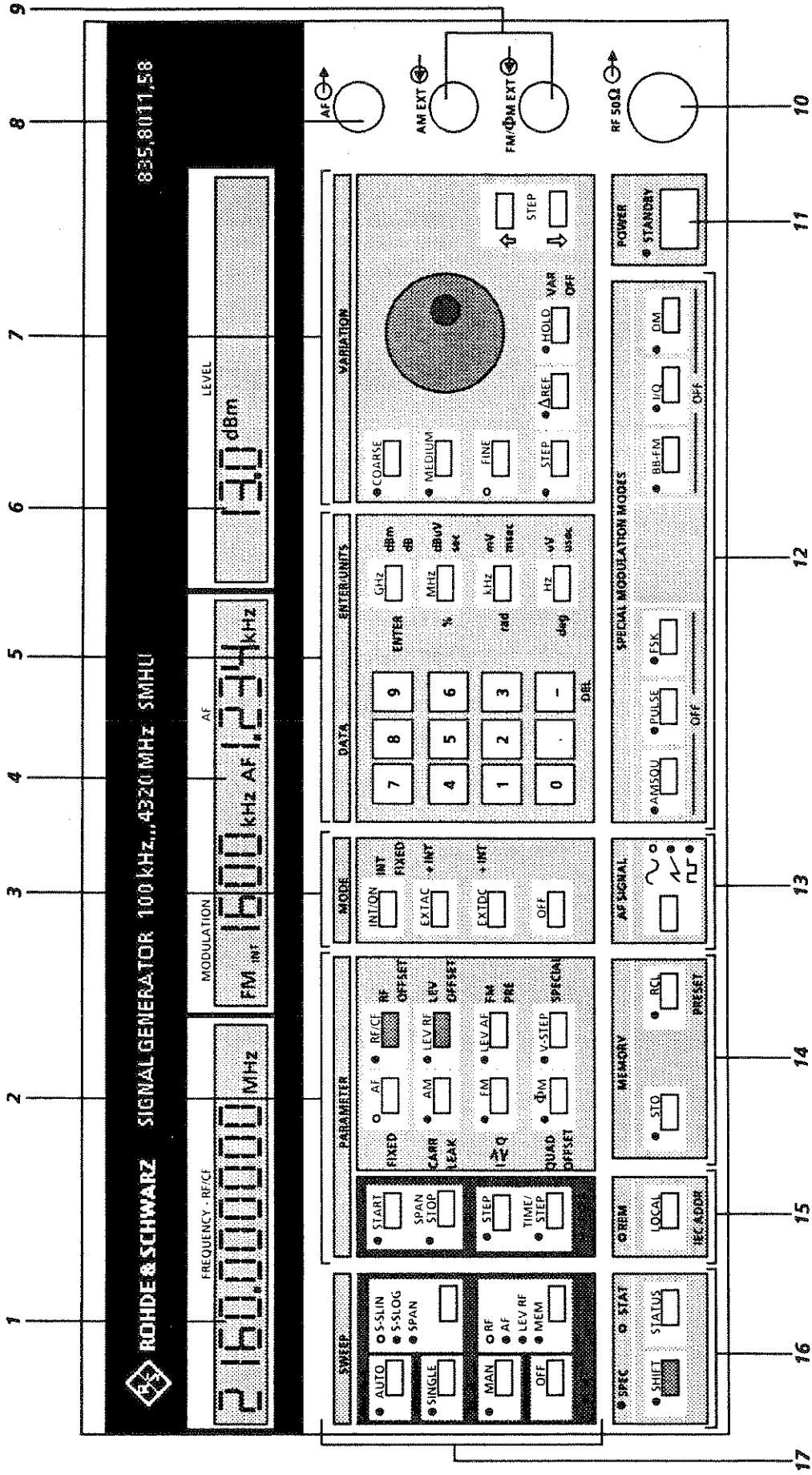
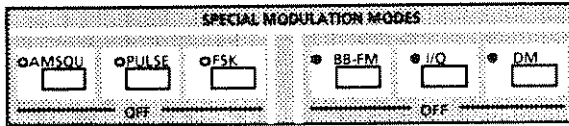

Fig. 2-1 Front panel view

12



Keypad to switch special modulation modes on/off.

16

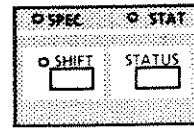

Front panel field to indicate special functions and status codes and to enter SHIFT functions.

13

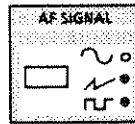

Keypad used for setting the currently required waveform of the internal AF synthesizer.

17

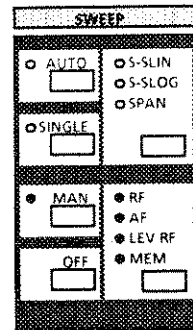

Keypad to select the operating modes and to activate or deactivate sweep mode.

14

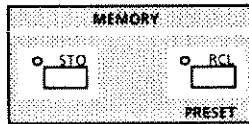

Keypad to store instrument settings and recall stored settings. For further information, refer to sections on "Store-Recall" and "Preset".

15

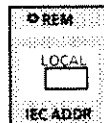

Front panel field to indicate the REMOTE state, as well as to switch to LOCAL mode (manual operation) or to enter and display the IEC bus address.

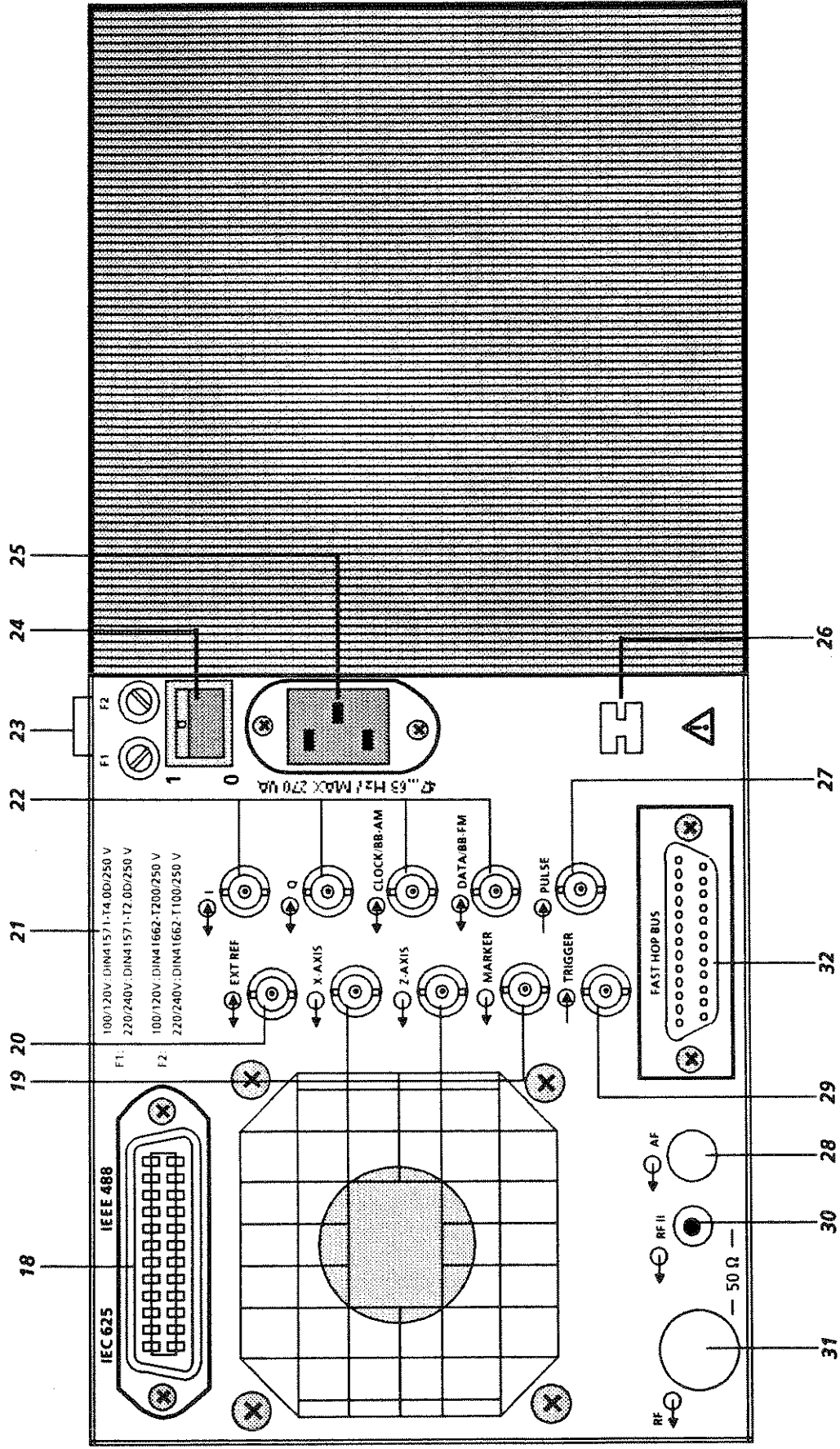
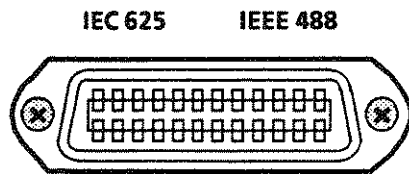

Fig. 2-2 Rear panel view

Rear panel view

18



IEC bus connector for remote control.

21

100/120V: DIN41571-T4.0D/250 V
 220/240V: DIN41571-T2.0D/250 V
 F1:
 100/120V: DIN41662-T200/250 V
 220/240V: DIN41662-T100/250 V
 F2:

Fuse values for the different supply voltages.

19

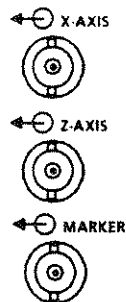

BNC outputs to control and trigger oscilloscopes or XY recorders. For further information, refer to section on "Sweep Outputs".

22

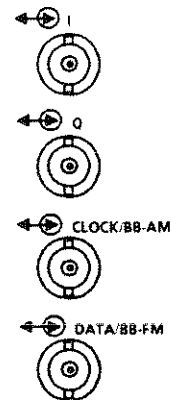

In-/outputs for modulation modes:
 I/Q, Coder, broadband-AM and broadband-FM

20

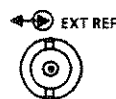

Output of the internal reference frequency (level 7 dBm) with an internal reference. Input of the external reference frequency (level > 100 mV (V_{rms})) with an external reference. The input or output reference frequency (normally 10 MHz) may also be switched to 5 MHz by means of special function "Reference Frequency 5 MHz". For further information, refer to section on "Internal/External Reference Frequency".

23

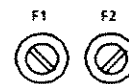

Fuse holders for power fuses F1 and F2. Prior to first turn-on of the instrument, the power supply and the fuses must be checked.

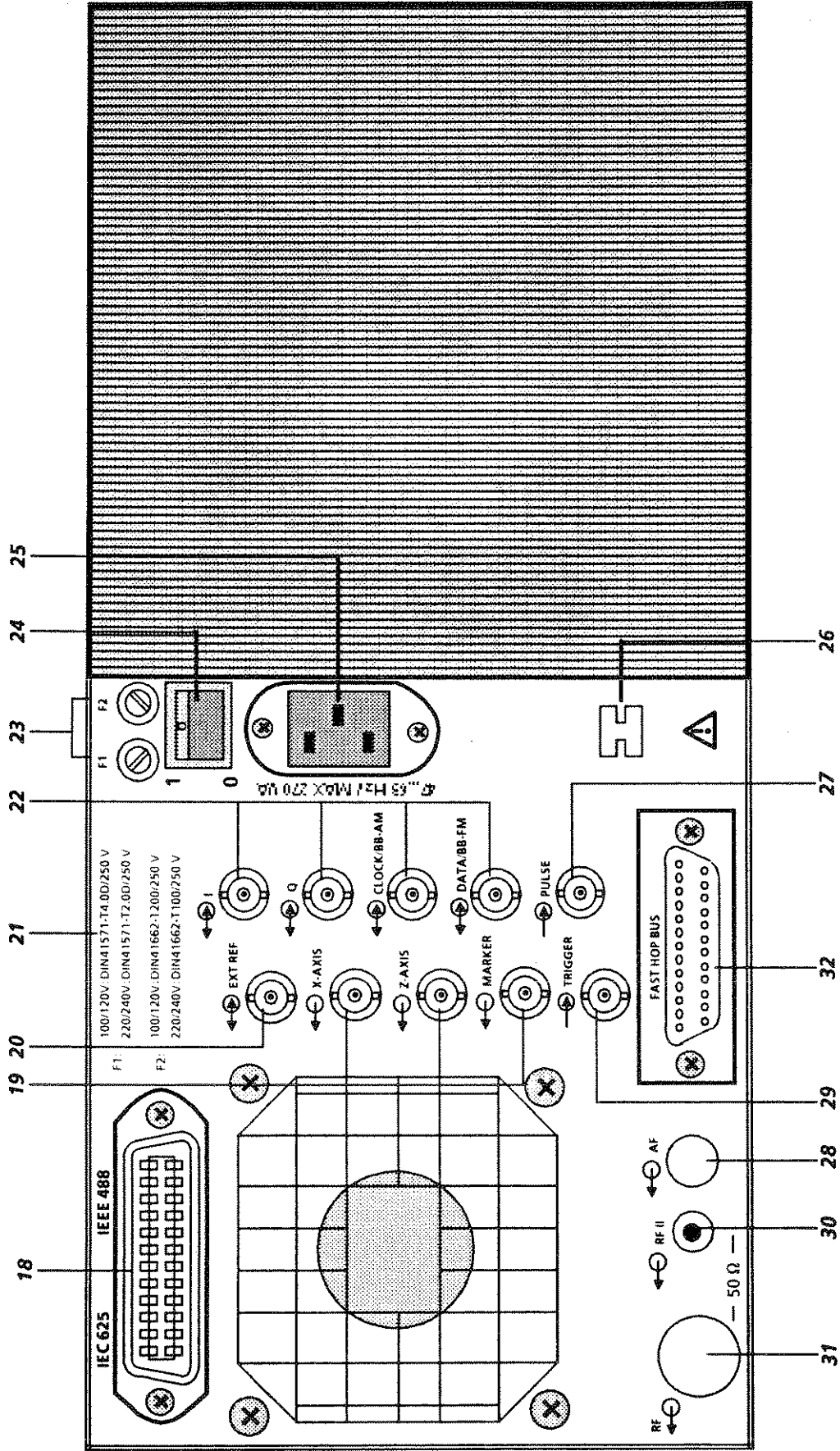
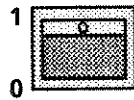

Fig. 2-2 Rear panel view

24



Power switch.

25

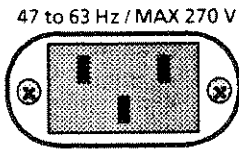

Power supply connection.

26



Voltage selector.

Position "115 V" for supply voltage 90 to 132 V.
Position "220 V" for supply voltage 198 to 264 V.

27

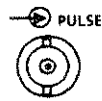

BNC input for PULSE modulation (TTL input). For further information, refer to section on "Modulation, PULSE".

28

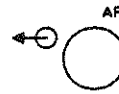

Cut-out provided for fitting the corresponding front panel socket to the rear panel of the instrument.

29

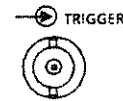

Trigger input for FAST mode.

30

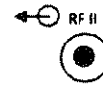

Second RF output for coherent carrier with I/Q modulation.

31

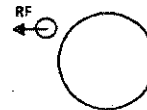

Cut-out provided for fitting the front panel RF output to the rear panel of the instrument.

32

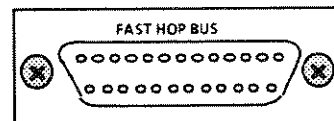

Fast Hop Bus connector

2.2 Preparations for Use

2.2.1 Power Fuse

Power fuses F1 and F2 are located on the rear panel of the instrument. The fuse values for the different voltage supplies are indicated on the label.

Table 2-1

Nominal voltage supply	Permissible voltage range	Position of voltage selector	Fuse	
			F1	F2
100 V; 120 V	90 to 132 V	"115 V"	T4.0D/250 V DIN 41571	T200/250 V DIN 41662
220 V; 240 V	198 to 264 V	"220 V"	T2.0D/250 V DIN 41571	T100/250 V DIN 41662

2.2.2 Power Supply

Signal Generator SMHU may optionally be operated with 100 V, 120 V, 220 V or 240 V. Prior to instrument turn-on, check the power supply and fuse. To change to another operating voltage, insert fuses F1 and F2 required for the respective voltage and set the voltage selector accordingly.

For supply voltage 100 V or 120 V, the voltage selector must be set to "115 V".

For supply voltage 220 V or 240 V, the voltage selector must be set to "220 V".

2.2.3 Rack Mounting

The instrument can be fitted into any 19" rack using the 19" adapter ZZA-94.

When fitting the instrument into a rack, ensure that the air inlet through the perforations in the side panels and the air outlet at the rear are not impeded.

Fitting instructions are included with the 19" adapter.

2.3 Operating Instructions

Signal Generator SMHU provides signals at the RF output ranging from 100 kHz to 4320 MHz in a level range from 13 dBm (19 dBm) to -140 dBm with AM or pulse modulation and FM or phase modulation. Combination of internal and external modulation source allows two-tone modulation. External AM and FM can be ac-or dc-coupled. At the AF output, a signal in the frequency range from 1 Hz to 100 kHz with an amplitude ranging from 0.2 mV to 2 V (V_p) is available.

The Generator can either be manually operated by means of keyboard or rotary knob for variation, or remote-controlled via the IEC bus interface.

Parameter Selection

The PARAMETER keypad is used for setting the parameter to which the subsequent numeric entries and variations apply. The parameter currently selected via keyboard entry is indicated by LED (on). Only one parameter can be activated at a time, with the exception of parameter V-STEP which is always set in combination with another parameter (to enter the STEP size for the STEP function).

The SHIFT parameters FIXED, RF OFFSET, LEV OFFSET, FM PRE, SPECIAL and MARKER (indicated by blue labelling) are set by first pressing the SHIFT key before the key for the currently required parameter is selected.

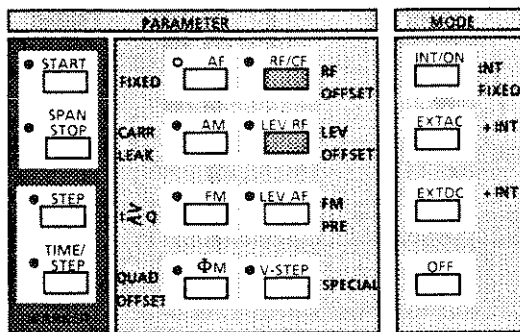

Keypad PARAMETER and MODE

Activating and Deactivating the Parameters

The following parameters can be selected: AM, FM, Φ M, LEV RF, LEV AF, RF OFFSET, LEV OFFSET, FM PRE and MARKER.

To activate a parameter its respective parameter key is pressed, followed by one of the following three keys (INT/ON, EXT AC, EXT DC) in the MODE keypad. The instrument then assumes the last used value stored for this parameter.

The parameters can also be switched on with a new numeric keypad entry using one of the ENTER/UNITS keys. If no data are entered in the DATA keypad, the instrument automatically assumes the last used value stored for this parameter.

To deactivate the parameter, its respective parameter key is pressed again, followed by the OFF key in the MODE keypad.

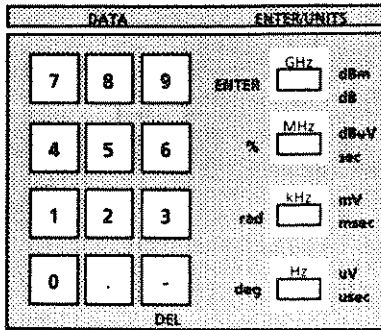

Keypad DATA and ENTER/UNITS

Numeric Keypad Entry

For numeric keypad entry, proceed in the following order:

PARAMETER — DATA — ENTER/UNITS

Example:



The parameter currently selected (respective parameter LED on) need not be set again for further entries once it has been set. This, however, does not apply to the SHIFT parameters FIXED, RF OFFSET, LEV OFFSET, FM PRE, SPECIAL and MARKER (blue labelling), which remain set for one entry only.

The value is set on the instrument following actuation of one of the ENTER/UNITS keys.

Numeric entries must always be terminated by pressing one of the ENTER/UNITS keys. To have parameters without unit set on the instrument, the ENTER key is used to terminate data entry.

Example:

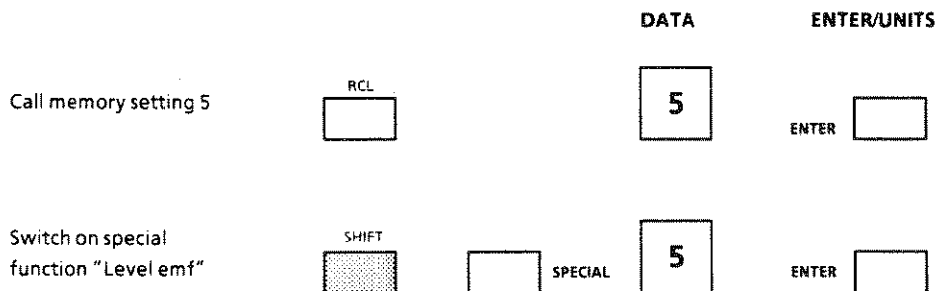

Correction of Entry

An entered value can be cleared again before it is set on the instrument (i.e. before pressing one of the ENTER/UNITS keys) by pressing the key of the currently selected parameter (respective LED on) or any of the other parameter keys. The numeral entered last is cleared by means of pressing the DEL key (minus sign key).

To deactivate the SHIFT function (set by actuation of the SHIFT key), press its key again.

Changing the Unit

To change the displayed RF level unit, the respective parameter is selected in the parameter keypad and the key for the required unit pressed in the ENTER/UNITS field.

If for example the level is indicated in mV but should be in dBm, proceed as follows:

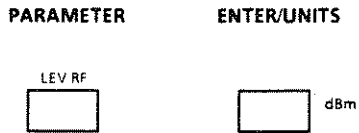

If the parameter is already set (LED on), its key need not be pressed again.

Variation

Variations of the following parameters AF, AM modulation depth, FM deviation, Φ M deviation, RF/CF, LEV RF and LEV AF are possible. The SHIFT parameters cannot be varied.

The STEP keys $\uparrow \downarrow$ in the VARIATION keypad have been provided to vary the currently set parameter in the PARAMETER keypad. It is also possible to use the rotary knob for variation, unless the HOLD function or MAN SWEEP are switched on.

Variations using the STEP keys $\uparrow \downarrow$ are made in individual steps or repeatedly by continuously pressing the key. For further information, refer to sections on "Variation".

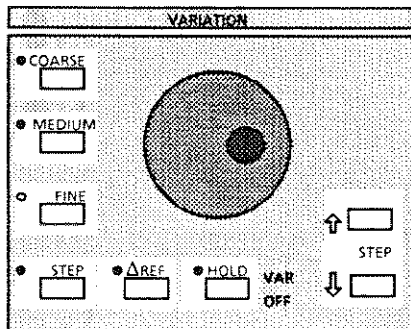

VARIATION Keypad

Sweep

The Signal Generator provides a staircase sweep for the RF, AF, LEV RF and memory MEM functions. Sweep parameters START, STOP, SPAN, STEP, TIME/STEP and MARKER are defined by numeric entries.

The keys in the SWEEP keypad are used to activate and deactivate the sweep and to select the sweep mode. For further information, refer to sections on "Sweep".

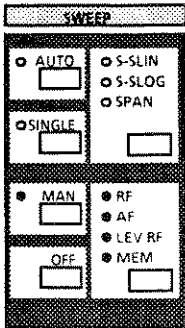

SWEEP keypad

Memory and Instrument Preset

The Generator features storage capabilities for instrument settings, which can later be retrieved at any time. This function is accessed using the keys in the MEMORY keypad.

Key sequence SHIFT and PRESET sets the Generator to a defined basic status. For further information, refer to sections "Store-Recall" and "Preset".

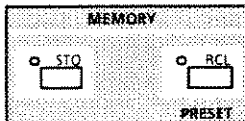

MEMORY keypad

AF Signal

The internal AF synthesizer provides sinewave, sawtooth or squarewave signals. To select the required signal form, use the key provided in the AF SIGNAL keypad. The currently selected signal form is indicated by LED.

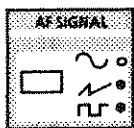

AF SIGNAL keypad

Special Modulation Modes

The special modulation modes AM SQU (AM squarewave), PULSE, FSK, BB-FM, I/Q and DM feature extensions for the modulation performance of the Signal Generator. Digital modulation (DM) is possible when the signal generator is appropriately fitted with the options GMSK Coder, DECT Coder or ADC Coder.

The special modulation modes are switched on by means of pressing the respective key in the SPECIAL MODULATION MODES keypad. To switch this mode off again, previously press the SHIFT key. For further information, refer to sections on "Modulation".

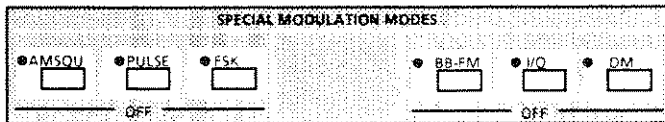

Keypad for SPECIAL MODULATION MODES

Special Functions

Special functions allow for additional instrument applications beyond those indicated on the keyboard. Whenever a special function is activated, the special functions LED SPEC is illuminated. For further information, refer to section on "Special Functions".

Status

Input errors are indicated in the MODULATION display by brief readout of the status code identifying the particular error and by flashing of the STATUS LED.

Function errors are indicated by continuous flashing of the STATUS LED. The status code describing the error appears in the MODULATION display upon actuation of the STATUS key.

Overrange/underrange settings are indicated by continuous lighting up of the STATUS LED. The status code describing the setting appears in the MODULATION display upon actuation of the STATUS key.

Continuous lighting up of the special functions LED SPEC indicates that a special function is currently activated. The status code describing the setting appears in the FREQUENCY display upon actuation of the STATUS key. For further information, refer to section on "Status".

IEC Bus Address

The set IEC bus address can be read out in the FREQUENCY display and set via keyboard entry. For further information, refer to section on "IEC Bus Address".

Displays

The **FREQUENCY** display reads out the RF in values with up to 10 digits.

This display is also used for readout of:

- sweep parameters,
- STEP size for STEP variation of RF,
- frequency offset,
- status codes of the currently selected special functions,
- external reference mode, and
- IEC bus address.

The information given in the **MODULATION** and **AF** display covers:

- type of modulation currently set,
- modulation depth and deviation,
- AF,
- set pre-emphasis,
- STEP sizes for the STEP variation of the modulation parameters and AF,
- status codes of function errors, input errors and overrange/underrange settings, and
- reference EXT LOW or EXT HIGH if the external modulation voltage is not 1 V (V_p).

The **LEVEL** display is used for readout of:

- level of the RF or AF output,
- STEP size for STEP variation of RF or AF level,
- level offset,
- value of the non-interrupting level setting,
- memory location number for MEMORY functions,
- measured values of internal test points (diagnostic test),
- reference OVERLOAD in case the RF output is externally overloaded.
- reference "OP. 2" depending on the option fitted.

Display of the SHIFT Parameters

The SHIFT parameters (blue front-panel labelling) are read out in their associated displays as long as the respective parameter key is hold down after pressing the SHIFT key.

Display of Entered Numeric Value

When a new numeric value is set on the instrument using the DATA keypad, the currently entered numerals for the new value are correspondingly read out in the display of the set parameter.

2.3.1 Switch-on Status

The Signal Generator is in STANDBY mode if power switch **24** positioned on the rear panel of the instrument is switched on and switch **11** on the front panel is not pressed. In this mode (STANDBY LED illuminated), the internal reference oscillator OCXO (oven controlled X-tal oscillator) is heated.

The Generator is in switch-on status if power switch **24** as well as switch **11** are pressed. If the instrument was not switched to STANDBY mode prior to turn-on, reference oscillator OXCO requires several minutes for warm-up to have its nominal frequency. During this warm-up period, "OVEN COLD" is displayed in the FREQUENCY display. Also error messages **40** and **41** may appear.

At turn-on, the Generator assumes the same operating status which was set when it was last powered off.

Exceptions:

- Local mode is always set.
- An SRQ can be output on the IEC bus each time the instrument is turned on.
- For setting the registers of the Service Request function, refer to sections "Service Request and Status Registers" and "Resetting of Device Functions".

At turn-on, a function test is performed checking the ROM and RAM contents. On detection of an error, the STATUS LED starts blinking. The respective status codes are read out in the MODULATION display following pressing of the STATUS key.

If the status which was set when the instrument was last powered off cannot be retrieved as a result of a memory error, the instrument assumes the preset status.

Display: Following turn-on, the set IEC bus address is briefly read out in the FREQUENCY display and the LEVEL display indicates whether options are fitted.

2.3.2 Internal/External Reference Frequency

Frequency at EXT REF input/output:	10 MHz (5 MHz)	
Internal reference mode:	Signal output 7 dBm	Socket EXT REF at rear panel of instrument.
External reference mode:	Signal input 0.1 to 2 V (V_{rms})	Socket EXT REF at rear panel of instrument.

A 10 MHz oven-controlled crystal oscillator is provided as an internal reference source for the Signal Generator. The reference source, whether internal or external, is selected via keyboard or IEC bus.

In internal reference mode, the internal reference signal with a frequency of 10 MHz or 5 MHz is available at socket EXT REF.

For external reference operation, an external signal with a frequency of 10 MHz or 5 MHz must be applied to socket EXT REF.

Instead of the normally used input or output reference frequency of 10 MHz, it is also possible to select 5 MHz frequency using special function "Reference Frequency 5 MHz".

Special function "Reference Frequency 5 MHz" : Activating code: 13
 Deactivating code: 14

The bandwidth for synchronisation of the instrument with the internal or external reference frequency can be changed using internal plug-in jumpers. They are located on the module "Fixed Frequencies" (819.6060).

Jumper position	Effect
X55A-B 1	Control bandwidth 1 Hz, serves to suppress hum sidebands and noise of the external reference outside the control bandwidth.
X55A-B 2	Control bandwidth 10 Hz, standard setting, optimum adjustment/matching to the internal OCXO.
X55A-B 3	Control bandwidth 100 Hz, e.g. use of a very low-noise external reference to improve the spectrum of the spectrum of the SMHU, inherent noise of the control loop approx. -130 dBc/Hz with $f_{\Delta F} = 30$ Hz, relating to 10 MHz.

Setting for external reference: RF/CF ——— EXT AC
 Setting for internal reference: RF/CF ——— INT/ON

Settings:

Example	Entry		IEC bus code
	PARAMETER	MODE	
Setting for external reference	RF/CF <input type="checkbox"/>	EXT AC <input type="checkbox"/>	REF:EXT
Setting for internal reference	RF/CF <input type="checkbox"/>	INT/ON <input type="checkbox"/>	REF:INT

Display: Letters "EXT REF" are read out in the frequency display if external reference is selected.

Note: The externally applied reference frequency 10 MHz (or 5 MHz) must not deviate from 10 MHz (5 MHz) by more than $\pm 3 \cdot 10^{-6}$.

Related instructions: Special functions

2.3.3 Frequency (RF)

Range: 100 kHz to 4320 MHz (settable from 1 kHz with restricted data)

Resolution: 0.1 Hz

Units: GHz, MHz, kHz, Hz

Setting: RF/CF _____ Data _____ Unit

Example	Entry			IEC bus code		
	PARAMETER	DATA		ENTER/UNITS		
Setting RF 500 MHz	<div style="text-align: center;">RF/CF</div> <input data-bbox="526 701 599 747" type="text"/>	5	0	0	<div style="text-align: center;">MHz</div> <input data-bbox="1029 701 1102 747" type="text"/>	RF 500 MHz

Display: RF output frequency is read out in the FREQUENCY display.

Related instructions: Frequency offset (RF OFFSET)
Sweep (RF)
Internal/external reference frequency

2.3.4 Frequency Offset (RF OFFSET)

The frequency offset can be adjusted in magnitude and sign. The RF output frequency is then lower than the displayed frequency by the negative offset, or higher by the positive offset. The offset is also effective in sweep mode.

Setting: SHIFT _____ RF OFFSET _____ Data _____ Unit

(Data with no sign for positive offset, with minus sign for negative offset.)

Switching on the RF offset without new data entry to its stored value:

SHIFT _____ RF OFFSET _____ INT/ON
or
SHIFT _____ RF OFFSET _____ Unit

Switching off the RF offset:

SHIFT _____ RF OFFSET _____ OFF
or
SHIFT _____ RF OFFSET _____ 0 (Zero) _____ Unit

Example	Entry	IEC bus code						
Setting negative offset 10 MHz	<table border="0"> <thead> <tr> <th data-bbox="467 281 634 306">PARAMETER</th> <th data-bbox="813 281 878 306">DATA</th> <th data-bbox="980 281 1105 306">ENTER/UNITS</th> </tr> </thead> <tbody> <tr> <td data-bbox="467 344 699 415">SHIFT <input type="checkbox"/> RF OFFSET</td> <td data-bbox="716 338 971 415">- 1 0</td> <td data-bbox="1008 344 1084 415"><input type="checkbox"/> MHz</td> </tr> </tbody> </table>	PARAMETER	DATA	ENTER/UNITS	SHIFT <input type="checkbox"/> RF OFFSET	- 1 0	<input type="checkbox"/> MHz	RF:OFFS -10 MHZ
PARAMETER	DATA	ENTER/UNITS						
SHIFT <input type="checkbox"/> RF OFFSET	- 1 0	<input type="checkbox"/> MHz						
Switching off the offset	<table border="0"> <thead> <tr> <th data-bbox="505 485 634 510">PARAMETER</th> <th data-bbox="792 485 857 510">MODE</th> </tr> </thead> <tbody> <tr> <td data-bbox="467 548 699 619">SHIFT <input type="checkbox"/> RF OFFSET</td> <td data-bbox="786 548 862 619">OFF <input type="checkbox"/></td> </tr> <tr> <td data-bbox="467 674 699 745">SHIFT <input type="checkbox"/> RF OFFSET</td> <td data-bbox="786 674 862 745">INT/ON <input type="checkbox"/></td> </tr> </tbody> </table>	PARAMETER	MODE	SHIFT <input type="checkbox"/> RF OFFSET	OFF <input type="checkbox"/>	SHIFT <input type="checkbox"/> RF OFFSET	INT/ON <input type="checkbox"/>	RF:OFFS:OFF RF:OFFS:ON
PARAMETER	MODE							
SHIFT <input type="checkbox"/> RF OFFSET	OFF <input type="checkbox"/>							
SHIFT <input type="checkbox"/> RF OFFSET	INT/ON <input type="checkbox"/>							

Display:

The letters "OFFSET" are read out in the FREQUENCY display if an offset is set.

Key sequence SHIFT ___ RF OFFSET is used to have the offset value read out in the FREQUENCY display as long as the key RF OFFSET is pressed.

Related instructions:

Sweep (RF)
Frequency (RF)

2.3.5 RF Level (LEV RF)

Range: - 140 to 13 dBm (0.02 μ V to 1 V), adjustable up to 19 dBm
With Option ADC-Coder:
 - 140 to 10 dBm (0.02 μ V to 0.7 V), adjustable up to 19 dBm

Resolution: 0.1 dBm

Units: dBm, dB μ V, mV, μ V

Setting: LEV RF ____ Data ____ Unit

Example	Entry			IEC bus code
	PARAMETER	DATA	ENTER/UNITS	
Setting RF level 10 dBm	LEV RF <input type="text"/>	<input type="text" value="1"/> <input type="text" value="0"/>	<input type="text"/> dBm	LEV:RF10DBM
	PARAMETER	MODE		
Switching off RF level	LEV RF <input type="text"/>	OFF <input type="text"/>		LEV:RF:OFF
Switching on RF level to stored value	LEV RF <input type="text"/>	INT/ON <input type="text"/>		LEV:RF:ON

Display: The level of the RF output signal is read out in the LEVEL display if the LEV RF parameter is set.

Following setting of the LEV AF parameter, the voltage of the AF output signal is read out in the LEVEL display including the remark AF.

Related instructions: Level offset
 Transient-free level settings
 Level emf
 AGC off

Note: Frequent level variations in automatic test systems might reduce the life utility of the attenuator. It is therefore recommended to carry out the level settings in few steps only, using the electronic level variation if possible.

2.3.6 Level Offset (LEV OFFSET)

Magnitude and sign of the level offset can be adjusted. The offset can be entered in dB only. The RF output level is lower than the displayed level by the negative offset or higher by the positive offset. The offset is also effective with a transient-free level setting.

Setting: SHIFT _____ LEV OFFSET _____ Data _____ dB

(Data with no sign for positive offset, with minus sign for negative offset.)

Switching on the offset without new data entry to its stored value:

SHIFT _____ LEV OFFSET _____ INT/ON
or
SHIFT _____ LEV OFFSET _____ dB

Switching off the offset: SHIFT _____ LEV OFFSET _____ OFF
or
SHIFT _____ LEV OFFSET _____ 0 (Zero) _____ dB

Example	Entry			IEC bus code
	PARAMETER	DATA	ENTER/UNITS	
Setting offset 3 dB	SHIFT <input type="checkbox"/> <input type="text"/> LEV OFFSET	<input type="text" value="3"/>	<input type="text"/> dB	LEV:RF:OFFS3DB
Switching off offset	SHIFT <input type="checkbox"/> <input type="text"/> LEV OFFSET	MODE <input type="text" value="OFF"/>		LEV:RF:OFFS:OFF
Switching on offset to stored value	SHIFT <input type="checkbox"/> <input type="text"/> LEV OFFSET	MODE <input type="text" value="INT/ON"/>		LEV:RF:OFFS:ON

Display: Letters "OFFSET" are read out in the LEVEL display if an offset is currently set.

The offset value is read out in the LEVEL display using the key sequence SHIFT _____ LEV OFFSET as long as the key LEV OFFSET is pressed.

Related instructions: Level (LEV RF)
Transient-free level settings
Level emf
AGC off

2.3.7 Transient-free Level Settings

In special function "Transient-free Level Settings", an electronic attenuation setting is used over a dynamic range of 20 dB instead of the level-interrupting mechanical attenuator.

The 20 dB transient-free range extends from the level set upon selection of this special function to 20 dB below. Within this particular 20 dB range, the level can be set via the keyboard or the rotary knob for variation or also via IEC bus.

If a level outside the 20 dB range is selected, the level-interrupting mechanical attenuator is again used for level setting. Starting at this new level, all further level settings within the 0 to -20 dB range will again be made transient-free.

When special function "Transient-free Level Settings" is switched on when already activated, this has the same effect as if the special function were switched on for the first time, i.e. the full -20 dB range will then be available starting from the currently set level.

Activating code: 1
Deactivating code: 2

Note: The specifications given in the enclosed Data Sheet as to level error, modulation depth error and distortion factor with AM do not apply if special function "Transient-free Level Settings" is activated.

This special function cannot be set in combination with:
Pulse modulation
Special function "AGC off"

Related instructions: RF level (LEV RF)
Level offset
Level emf
AGC off
Special functions

2.3.8 Level emf

If special function "Level emf" is selected, no longer the RF voltage value into 50 Ω is indicated but the emf value of the RF voltage. The emf value is read out if one of the units dB μ V, mV oder μ V is selected.

Activating code: 3
Deactivating code: 4

Related instructions: RF level (LEV RF)
Level offset
Transient-free level settings
AGC off
Special functions

2.3.9 AGC Off

The special function "AGC off" is used to switch the internal automatic level control to sample-and-hold mode. It is provided for multi-transmitter measurements to obtain a higher intermodulation ratio.

Activating code: 5
Deactivating code: 6

When special function "AGC off" is selected, a calibration of the level control voltage is always performed with each new RF or level setting. As a result of this calibration being performed, a longer settling time is required for the level. If the level accuracy obtained by the calibration is not required, this longer settling time may be avoided using special function "Level Control Voltage by Memory Lookup". The table in the memory of the controller can be regenerated with the aid of a calibration routine without using additional measuring equipment. The calibration routine should always be called after repairs on the controller when the system has warmed up (cf. service manual).

Special function "Level Control Voltage by Memory Lookup": Activating code: 7
Deactivating code: 8

Calibration routine for "Level Control Voltage by Memory Lookup": Special function code: 68

Note: The specifications in the enclosed Data Sheet as to level error and VSWR do not apply if special functions "AGC off" or "Level Control Voltage by Memory Lookup" are currently selected.

Special function "AGC off" cannot be set in combination with:
AM
Level sweep
Special function "Transient-free Level Settings"

Related instructions: RF level (LEV RF)
Level offset
Level emf
Special functions

2.3.10 Resetting Overvoltage Protection

In the case of overloading of the RF output by an externally applied signal, the overvoltage protection is activated. This is indicated in the LEVEL display by "OVERLOAD" and "OFF".

Key sequence LEV RF__INT/ON resets the overvoltage protection.

Example	Entry		IEC bus code
Resetting over-voltage protection	PARAMETER LEV RF <input type="text"/>	MODE INT/ON <input type="text"/>	LEV:RF:ON

2.3.11 Internal AF Modulation Frequency

The SMHU Signal Generator features an AF synthesizer and a fixed frequency generator as modulation sources. Both these sources can be activated independently of each other for various modulations and can both be switched to the AF output socket (cf. also sections "Modulation, AM, FM, Φ M" and "Modulation, Two-tone").

AF synthesizer:

Frequency range: 1 Hz to 100 kHz
Resolution: 1 Hz (4-digit display, floating point)

Fixed frequency generator: 400 Hz, 1000 Hz

Each modulation source can be switched off by 0 Hz entry (advantageous for maximal mode suppression).

Setting the AF synthesizer: AF ____ Data ____ Unit

Deactivating the AF synthesizer: AF ____ 0 ____ Hz

Setting the fixed frequency generator:

or: SHIFT ____ FIXED ____ 1 ____ kHz
SHIFT ____ FIXED ____ 400 ____ Hz

Deactivating the fixed frequency generator:

SHIFT ____ FIXED ____ 0 ____ Hz

Switching the AF synthesizer to AF socket:

AF ____ INT/ON

Switching the fixed frequency generator to AF socket:

or: SHIFT ____ FIXED ____ INT/ON
AF ____ SHIFT ____ INT FIXED

The level at the AF socket can be adjusted between 0.2 mV to 2 V (V_p) (cf. section "AF level").

Note: If two-tone modulation and special function "Internal Modulation via Attenuator" are simultaneously switched on, the AF synthesizer signal is automatically applied via the attenuator to the AF socket, even if the fixed frequency generator was switched to AF socket before.

Example	Entry			IEC bus code
Setting AF synthesizer to 123 Hz Switching off AF synthesizer Setting fixed frequency generator to 1 kHz	PARAMETER AF <input type="text"/> AF <input type="text"/> SHIFT <input checked="" type="checkbox"/> FIXED <input type="text"/>	DATA <input type="text" value="1"/> <input type="text" value="2"/> <input type="text" value="3"/> <input type="text" value="0"/> <input type="text" value="1"/>	ENTER/UNITS <input type="text"/> Hz <input type="text"/> Hz <input type="text"/> kHz	AF 123 HZ AF 0 HZ AF:FIX 1 KHZ
Switching fixed frequency generator to AF socket Switching AF synthesizer to AF socket	PARAMETER SHIFT <input checked="" type="checkbox"/> FIXED <input type="text"/> AF <input type="text"/>	MODE INT/ON <input type="text"/> INT/ON <input type="text"/>		AF:OUT:FIX AF:OUT:SYNTH

Display: The AF frequency is read out in the AF display. The fixed frequencies are identified by "F" and indicated in 2-digit form only.

For internal modulation, the frequency of the currently selected modulation source is indicated. Without internal modulation, the frequency of the AF socket output signal is read out.

Related instructions:

- AF level
- AF signal
- Modulation (AM, FM, Φ M)
- Modulation, two-tone
- Special functions

2.3.12 AF Signal

The internal AF synthesizer supplies signals in sine, sawtooth or square waveforms for internal modulation as well as at the AF output socket. The required signal form is selected using the key in the AF SIGNAL keypad. The signal form currently set is indicated by LED.

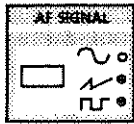

Frequency range sine: 1 Hz to 100 kHz
sawtooth: 1 Hz to 2 kHz
square: 1 Hz to 2 kHz

The sawtooth signal form is possible to be inverted by means of special function "AF Sawtooth Signal Inverted".

Activating code: 37
Deactivating code: 38

Related instructions: Internal AF modulation frequency
AF level
Modulation (AM, FM, Φ M)
Modulation, two-tone

2.3.13 AF Level (LEV AF)

Setting the AF level function means setting the level of the AF signal at the AF socket signal output. This has no effect on deviation and modulation depth of the internal modulation, which are determined via the deviation or modulation depth settings.

Exception: In special function "Internal Modulation via Attenuator", the internal modulation signal may also be determined via AF level setting. This is used for instance for two-tone modulation with various modulations.

Range: 0.2 mV to 2 V (V_p)

Resolution up to 200 mV: 0.2 mV
over 200 mV: 2 mV

Setting: LEV AF ____ Data ____ Unit

Example	Entry			IEC bus code
	PARAMETER	DATA	ENTER/UNITS	
Setting AF level 150 mV	LEV AF <input type="text"/>	<input type="text" value="1"/> <input type="text" value="5"/> <input type="text" value="0"/>	<input type="text"/> mV	LEV:AF:150 MV
Switching off level at AF socket	LEV AF <input type="text"/>	MODE <input type="text" value="OFF"/>		LEV:AF:OFF
Switching on level at AF socket to stored value	LEV AF <input type="text"/>	MODE <input type="text" value="INT/ON"/>		LEV:AF:ON

Display: If parameter LEV AF is set, the voltage of the AF output signal is read out in the LEVEL display including letters "AF".

Following setting of parameter LEV RF, the LEVEL display shows the level value of the RF output signal.

Related instructions: Internal AF modulation frequency
 AF signal
 Modulation (AM, FM, ΦM)
 Modulation, two-tone
 RF level

2.3.14 Modulation, AM

Modulation depth: 0 to 100%
Resolution: 0.1%
Modulation frequency range:
 internal: 10 Hz to 50 kHz
 external: 10 Hz to 50 kHz (EXT AC)
 dc to 50 kHz (EXT DC)

It is possible that either both internal modulation sources or one internal and one external modulation source are simultaneously activated (see section "Modulation, Two-tone").

With increasing level in the range from 7 dBm to 13 dBm, the specified AM data are guaranteed only for a linearly decreasing modulation depth. Setting a too large modulation depth leads to status display "2" (AM not specified with set level).

AM cannot be set in combination with: Pulse modulation
 Special function "AGC off"

Setting: AM ____ Data ____ %

Selection of modulation source:

internal AF synthesizer: AM ____ INT/ON
internal fixed frequency
generator: AM ____ SHIFT ____ INT FIXED
external ac-coupling: AM ____ EXT AC
external dc-coupling: AM ____ EXT DC
Two-tone (ac): AM ____ SHIFT ____ EXT AC + INT
Two-tone (dc): AM ____ SHIFT ____ EXT DC + INT

Selection of internal modulation frequency: Cf. section "Internal AF Modulation Frequency"

Switching off AM: AM ____ OFF

Switching on AM to stored setting: AM ____ %

Example	Entry			IEC bus code
	PARAMETER	DATA	ENTER/UNITS	
Setting and switching on AM with m = 80%	AM <input type="text"/>	<input type="text" value="8"/> <input type="text" value="0"/>	% <input type="text"/>	AM 80 %
	PARAMETER	MODE		
Selecting internal AF synthesizer as modulation source	AM <input type="text"/>	INT/ON <input type="text"/>		AM:INT
Switching to external modulation source	AM <input type="text"/>	EXT AC <input type="text"/>		AM:EXT:AC
Switching off AM	AM <input type="text"/>	OFF <input type="text"/>		AM:OFF

Display:

AM ^{EXT DC}_{INT} %
 .

If amplitude modulation is currently set, the display may read:

AM ^{EXT} , AM ^{EXT DC} , AM _{INT} , AM ^{EXT}_{INT} , AM ^{EXT DC}_{INT}

depending on the modulation source selected.

The modulation depth is specified in 3-digit form in the MODULATION display. This display is used for modulation display with AM as well as for deviation display with FM or Φ M. If AM and FM or AM and Φ M are simultaneously set, the value currently read out in the MODULATION display refers to the parameter (AM, FM or Φ M) that was selected last via parameter keypad.

In the case of internal modulation, the frequency of the selected internal modulation source is read out in the AF display.

Related instructions:

RF level (LEV RF)
 Internal AF modulation frequency
 Modulation, external source
 Modulation, two-tone
 Special functions

2.3.16 Modulation, FM

Deviation: 0 to 3200 kHz (depending on carrier frequency)

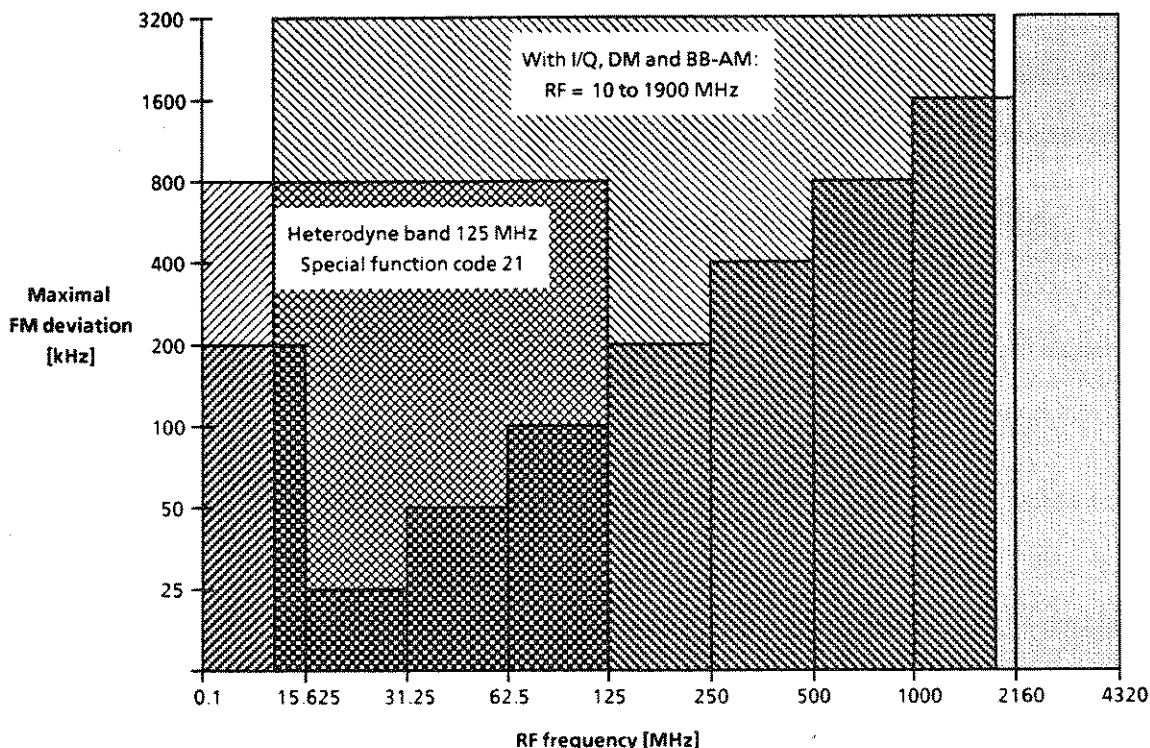

Fig. 2-3 FM deviation limits depending on RF frequency

Resolution: < 1% or 10 Hz

Modulation frequency range

internal: 10 Hz to 100 kHz
 external: 10 Hz to 100 kHz (EXT AC)
 dc to 100 kHz (EXT DC)

It is possible that both internal modulation sources or one internal and one external modulation source are simultaneously activated (cf. section "Modulation, Two-tone").

The RF output signal is no longer phase-synchronized if FM is set.

Setting: FM ___ Data ___ Unit

Selection of modulation source:

internal AF synthesizer: FM ___ INT/ON
 internal fixed frequency generator: FM ___ SHIFT ___ INT FIXED
 external ac-coupling: FM ___ EXT AC
 external dc-coupling: FM ___ EXT DC
 Two-tone (ac): FM ___ SHIFT ___ EXT AC + INT
 Two-tone (dc): FM ___ SHIFT ___ EXT DC + INT

Selection of internal modulation frequency:

Cf. section "Internal AF Modulation Frequency"

Switching off FM:

FM ___ OFF

Switching on FM to stored setting:

FM — Unit

Example	Entry			IEC bus code
Setting and switching on FM with 40 kHz deviation	PARAMETER FM <input type="text"/>	DATA <input type="text" value="4"/> <input type="text" value="0"/>	ENTER/UNITS kHz <input type="text"/>	FM 40 KHZ
Select fixed frequency generator as internal modulation source	PARAMETER FM <input type="text"/>	MODE SHIFT <input type="text"/> INT FIXED		FM:INT:FIXED
Switching to external modulation source	FM <input type="text"/>	EXT AC <input type="text"/>		FM:EXT:AC
Switching off FM	FM <input type="text"/>	OFF <input type="text"/>		FM:OFF

Display:

FM EXT DC INT kHz

If frequency modulation is currently set, the display may read:

FM EXT, FM EXT DC, FM INT, FM EXT INT, FM EXT DC INT

depending on the modulation source selected.

The deviation is specified in 3-digit form in the MODULATION display. This display is used for modulation display with AM as well as for deviation display with FM or ΦM. If AM and FM or AM and ΦM are simultaneously set, the value currently read out in the MODULATION display refers to the parameter (AM, FM or ΦM) that was selected last via parameter keypad.

In the case of internal modulation, the frequency of the selected internal modulation source is read out in the AF display.

Related instructions:

- Internal AF modulation frequency
- Modulation, external source
- Modulation, two-tone
- Modulation, FM PRE
- Special functions

2.3.17 Modulation, Broadband-FM (BB-FM), (only with SMHU .58)

- RF range:** 10 MHz to 1900 MHz, settable from 1 MHz to 2000 MHz
- Deviation:** 50 kHz to 50 MHz (settable from 1 kHz)
- Resolution:** < 1 % or 1 kHz
- Modulation frequency:** internal: 20 Hz to 100 kHz
external: 20 Hz to 20 MHz

The modulation input BB-FM is situated at the rear of the instrument. The input resistance of the instrument is factory-set to 50 Ω . An internal plug-in jumper can be connected such that input resistance amounts to 75 Ω . The jumper is located on the broadband modulator module (1002.4251).

The positions of the pins are:

Input resistance	Position
50 Ω	XB 60/2-3
75 Ω	XB 60/ 1-2

To achieve the deviation accuracy guaranteed in the data sheet a signal with $U_s = 1$ V must be fed in. Divergences from the required input voltage are not indicated.

Switching on BB-FM: BB-FM key in the SPECIAL MODULATION MODES keypad

Entry of deviation: FM ____ Data ____ Unit

Selection of modulation source:

internal AF synthesizer: FM ____ INT/ON
internal fixed frequency generator: FM ____ SHIFT ____ INT FIXED
external AC coupling: FM ____ EXT AC

Switching off BB-FM:

or SHIFT ____ BB-FM
FM ____ OFF

Example	Entry	IEC-bus code
Switching on BB-FM	SPECIAL MODULATION MODES BB-FM <input type="checkbox"/>	FM:BROADBAND:INT :EXT
Switching off BB-FM	SHIFT <input type="checkbox"/> BB-FM <input type="checkbox"/>	FM:BROADBAND:OFF
Setting deviation to 50 MHz	PARAMETER DATA ENTER/UNITS FM 5 0 MHz <input type="checkbox"/> <input type="checkbox"/> <input type="checkbox"/> <input type="checkbox"/>	FM:BROAD 50 MHz
Selecting AF-synthesizer as internal modulation source	PARAMETER MODE FM INT/ON <input type="checkbox"/> <input type="checkbox"/>	FM:BROADBAND:INT
Switching to external modulation source	FM EXT AC <input type="checkbox"/> <input type="checkbox"/>	FM:BROADBAND:EXT
Switching off BB-FM	FM OFF <input type="checkbox"/> <input type="checkbox"/>	FM:BROADBAND:OFF

Display:



If BB-FM is switched on, it is indicated by the illuminated LED of the BB-FM key and depending on the modulation source selected

FM _{BB INT} , **FM** _{EXT BB}

appears in the modulation display.

Deviation can be read in 3-digit form in the modulation display. This display is used for both modulation display with AM and deviation display with FM. If AM and FM are simultaneously set, the value of the parameter that was selected last via parameter keypad is displayed.

In the case of internal modulation, the frequency of the selected internal modulation source is read out in the AF display.

Note:

Broadband-FM cannot be set simultaneously with Φ M
DM

Related instructions:

AF modulation frequency, internal
Special functions

2.3.18 Modulation, ΦM

Deviation: 0 to 320 rad (depending on the carrier frequency)

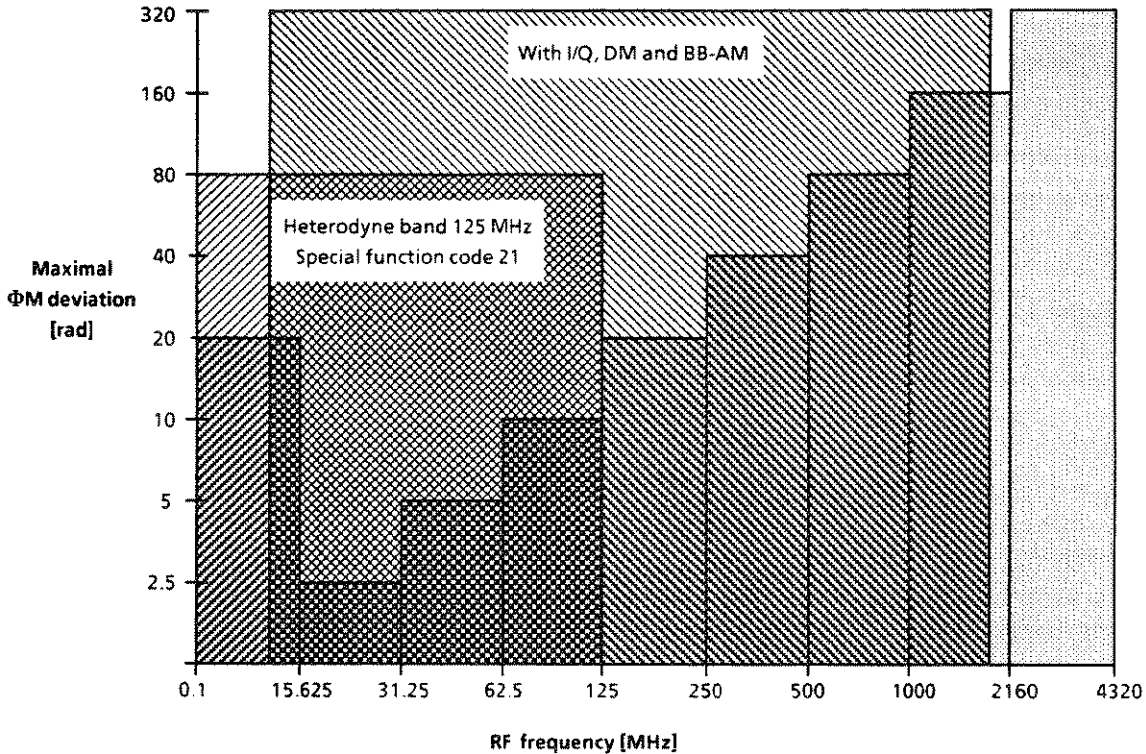

Fig. 2-4 ΦM deviation limits depending on RF frequency

Resolution: < 1% or 0.001 rad

Modulation frequency range
internal and external: 10 Hz to 10 kHz

It is possible that both internal modulation sources or an internal and an external modulation source are simultaneously activated (cf. section "Modulation, Two-tone").

The RF output signal is no longer phase-synchronized if ΦM is set.

Setting: ΦM _____ Data _____ rad

Selection of modulation source:
 internal AF synthesizer: ΦM _____ INT/ON
 internal fixed frequency generator: ΦM _____ SHIFT _____ INT FIXED
 external ac-coupling: ΦM _____ EXT AC
 Two-tone (ac): ΦM _____ SHIFT _____ EXT AC + INT

Selection of internal modulation frequency: Cf. section "Internal AF Modulation Frequency".

Switching off ΦM : ΦM _____ OFF

Switching on ΦM to stored setting:
 ΦM _____ rad

Example	Entry			IEC bus code
Setting and switching on ΦM with 10 rad deviation	PARAMETER ΦM <input type="text"/>	DATA <input type="text" value="1"/> <input type="text" value="0"/>	ENTER/UNITS rad <input type="text"/>	PHM 10 RAD
Selecting internal AF synthesizer as modulation source	PARAMETER ΦM <input type="text"/>	MODE INT/ON <input type="text"/>		PHM:INT
Switching off ΦM	ΦM <input type="text"/>	OFF <input type="text"/>		PHM:OFF

Display:

ΦM EXT INT 10 rad

If ΦM is currently set, the display may read:

ΦM EXT, ΦM INT, ΦM EXT INT

depending on the modulation source selected.

The phase deviation is specified in 3-digit form in the MODULATION display. This display is used for modulation display with AM as well as for deviation display with FM or ΦM . If AM and FM or AM and ΦM are simultaneously set, the value currently read out in the MODULATION display refers to the parameter (AM, FM or ΦM) that was selected last via parameter keypad.

In the case of internal modulation, the frequency of the selected internal modulation source is read out in the AF display.

Related instructions:

Internal AF modulation frequency
 Modulation, external source
 Modulation, two-tone
 Special functions

2.3.19 Modulation, FM Pre-emphasis (FM PRE)

The Signal Generator features the capability for pre-emphasis (50 or 75 μ s) of internal or external FM. If pre-emphasis function FM PRE is selected, only 1/4 of the maximal deviation can be set.

Deviation: 0 to 1/4 max. deviation

Modulation frequency range:
internal and external: 10 Hz to 15 kHz

Pre-emphasis: 50 μ s, 75 μ s

Setting: SHIFT _____ FM PRE _____ Data _____ μ sec

Switching on pre-emphasis without new data entry to stored value:

SHIFT _____ FM PRE _____ INT/ON

Switching off pre-emphasis: SHIFT _____ FM PRE _____ OFF

Example	Entry			IEC bus code
	PARAMETER	DATA	ENTER/UNITS	
Setting pre-emphasis 50 μ s	SHIFT <input type="checkbox"/> FM PRE	<input type="text" value="5"/> <input type="text" value="0"/>	<input type="text"/> μ sec	FM:PRE:50 US
Switching off pre-emphasis	SHIFT <input type="checkbox"/> FM PRE	MODE OFF	<input type="text"/>	FM:PRE:OFF
Switching on pre-emphasis to stored value	SHIFT <input type="checkbox"/> FM PRE	MODE INT/ON	<input type="text"/>	FM:PRE:ON

Display: If frequency modulation with pre-emphasis is currently set, the MODULATION display may read:

PREEMPHASIS 50 μ s or PREEMPHASIS 75 μ s

depending on the selected time constant.

Related instructions: Modulation, FM

2.3.20 Modulation, FSK

Frequency modulation with digital modulation signals is basically possible in operating mode FM-EXT. The required levels of the modulation signals are specified in section "Modulation, External Source".

In the FSK mode, TTL signals can be fed into the FM/ΦM modulation input for digital frequency modulation. The deviation setting is as described in section "Modulation, FM".

Special function "Polarity FSK" has been provided for selecting the polarity of the FSK signal. If this special function is switched off, the output frequency with a LOW input level is equal to the set RF minus deviation and equal to the set RF plus deviation with a HIGH level. Activating special function "Polarity FSK" reverses the polarity.

Special function "Polarity FSK Inverted": Activating code: 27
 Deactivating code: 28

Switching on modulation FSK: Key FSK in keypad for SPECIAL MODULATION MODES

Switching off modulation FSK: SHIFT FSK
 or FM INT/ON
 or FM EXT AC
 or FM EXT DC
 or FM OFF

The output signal is no longer phase-synchronized if FSK modulation is selected.

Example	Entry	IEC bus code
Switching on modulation FSK to stored deviation Switching off modulation FSK	<p style="text-align: center;">SPECIAL MODULATION MODES</p> <p style="text-align: center;">FSK <input type="checkbox"/></p> <p>SHIFT <input checked="" type="checkbox"/> FSK <input type="checkbox"/></p>	<p style="text-align: center;">FM:FSK</p> <p style="text-align: center;">FM:OFF</p>
Setting deviation 25 kHz	<p style="text-align: center;">PARAMETER DATA ENTER/UNITS</p> <p style="text-align: center;">FM <input type="text" value="2"/> <input type="text" value="5"/> kHz</p>	<p style="text-align: center;">FM:FSK 25 KHZ</p>

Display: If FSK is currently set, this is indicated by LED of key FSK (illuminated) as well as MODULATION display reading:

FM EXT DC

Related instructions: Modulation, FM
 Modulation, external source
 Special functions

2.3.21 Modulation, AM Square (AM SQU)

Amplitude modulation with digital modulation signals is generally possible in operating mode AM-EXT DC. The required levels of the modulation signals are specified in section "Modulation, External Source".



In the AM SQU mode, TTL signals can be fed into the AM EXT modulation input for digital amplitude modulation. The range of modulation is determined by the respective entry for the modulation depth.

Special function "Polarity AM SQU" has been provided for selecting the polarity of the modulated signal. If this special function is switched off, the output level with a HIGH TTL input level exceeds the set level by the selected modulation depth and falls below the set level by the particular modulation depth in the case of LOW input level. Activating special function "Polarity AM SQU" reverses the polarity.

Special function "Polarity AM SQU Inverted":
 Activating code: 29
 Deactivating code: 30

Switching on modulation AM SQU: AM SQU key in SPECIAL MODULATION MODES keypad

Switching off modulation AM SQU:
 or SHIFT _____ AM SQU
 or AM _____ INT/ON
 or AM _____ EXT AC
 or AM _____ EXT DC
 or AM _____ OFF

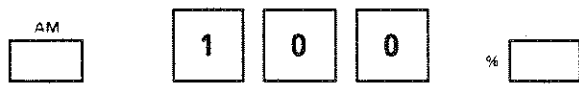
Example	Entry	IEC bus code
Switching on modulation AM SQU	SPECIAL MODULATION MODES 	AM:SQU
Switching off modulation AM SQU		AM:OFF
Setting modulation depth 100%	PARAMETER DATA ENTER/UNITS 	AM:SQU 100 %

Display: If AM SQU is currently selected, this is indicated by LED of key AM SQU (illuminated) and MODULATION display reads:

AM EXT DC

Related instructions:
 Modulation, AM
 Modulation, external source
 Special functions

2.3.23 Modulation, I/Q, (only with SMHU .58)

In the operating mode I/Q modulation, external modulation signals can be fed into the modulation inputs "I" and "Q" at the rear of the instrument for vector modulation.

RF range: 10 MHz to 1900 MHz, settable from 1 MHz to 2000 MHz

I/Q inputs: Input voltage range: ± 0.5 V
 Input resistance: 50 Ω
 Bandwidth: DC ... 200 MHz

Level control of the summation vector = $\sqrt{I^2 + Q^2} = 0.5$ V corresponds to the RF-level displayed.

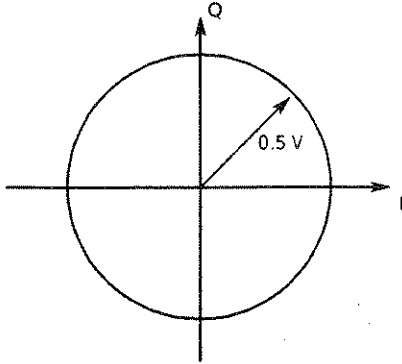

Switching on I/Q modulation: use the I/Q key in the SPECIAL MODULATION MODES keypad

Switching off I/Q modulation: SHIFT _____ I/Q

Example	Entry	IEC-bus code
Switching on I/Q modulation	<p style="text-align: center;">SPECIAL MODULATION MODES</p> <p style="text-align: center;">I/Q <input type="checkbox"/></p>	IQ:ON
Switching off I/Q modulation	<p style="text-align: center;">SHIFT <input type="checkbox"/> I/Q <input type="checkbox"/></p>	IQ:OFF

Display: If I/Q modulation is currently set, the LED of the I/Q key is illuminated and "I/Q" appears in the MODULATION display.

Note: I/Q modulation cannot be set simultaneously with:
 AM
 Broadband-AM
 Level sweep
 DM
 Special function "Transient-free Level Setting"

Self-calibration of the I/Q-modulator that can be called by means of a special function allows precise and repeatable measurements. The calibration routine should be called during warming-up of the instrument (about 1 hour) before carrying out measurements or when temperature variations of more than 5°C occur.

Special function "Calibration routine for I/Q-modulator": Code: 320

If I/Q-modulation is switched on, the continuous level control is automatically replaced by Sample and Hold Mode "AGC off". When the frequency or level is changed, the level is recalibrated. If the time necessary for the calibration process or switching to CW-mode are disturbing, the special function "Level Control Voltage by Memory Lookup" can be used. In this case correction values of level setting specified in a table in the memory can be adopted when changing frequency or level. The table can be recreated without additional measuring equipment, simply using a calibration routine. The latter should always be called following repair works when the instrument has warmed up (cf. Service Manual).

Special function "Level Control Voltage by Memory Lookup":

Activating code: 7

Deactivating code: 8

Calibration routine for "Level Control Voltage by Memory Lookup":

Activating code: 68

Related Instructions: I/Q-impairment
Special functions

2.3.24 I/Q-Impairment (CARR LEAK, I><Q, QUAD OFFSET), (only with SMHU .58)

For simulation of impairment of the vector modulation (I/Q, GMSK), the special function "I/Q-impairment input" allows the input of:

- carrier leakage
- different input voltages for the I- and Q-vektors (I><Q)
- quadrature offset.

If the special function is switched on, the parameter keys AM, FM and Φ M are switched to the parameters CARR LEAK, I><Q and QUAD OFFSET that are characterized by grey labelling. The modulations AM, FM and Φ M cannot be entered, if the special function is switched on.

Special function "I/Q-impairment input":

Activating code: 301

Deactivating code: 302

Effect of I/Q-impairment:

Carrier leakage:

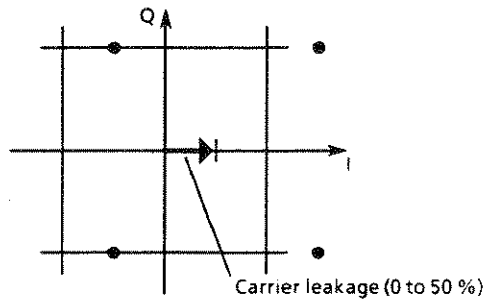

$I \neq Q$:

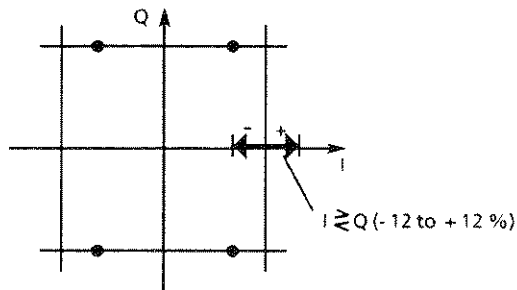

Quadrature offset:

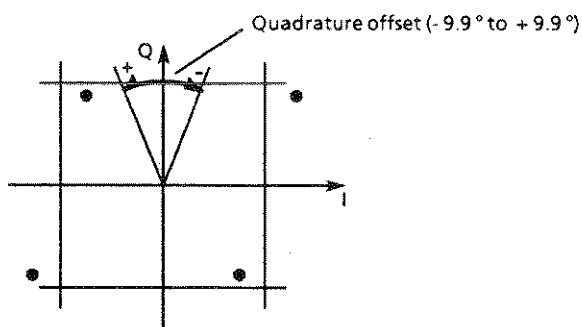

Parameter setting ranges:

Parameter	Setting range	Resolution
CARR LEAK	0 to 50 %	1 %
$I \neq Q$	-12 to +12 %	0.1 %
QUAD OFFSET	-9.9 to +9.9°	0.1°

Note: When switching off the special function "I/Q-impairment input" the parameters are set to zero.

Example	Entry			IEC-bus code
	PARAMETER	DATA	ENTER/UNITS	
Switching on the special function "I/Q-impairment"	SHIFT <input type="checkbox"/> SPECIAL	3 0 1	ENTER <input type="checkbox"/>	---
Entry of carrier leakage of 10 %	CARR LEAK <input type="checkbox"/>	1 0	% <input type="checkbox"/>	IQ:CARR 10 PCT
Entry of I > Q of -5 %	I > Q <input type="checkbox"/>	- 5	% <input type="checkbox"/>	IQ:IMBALANCE-5 PCT
Entry of quadrature offset of 4 degrees	QUAD OFFSET <input type="checkbox"/>	4	deg <input type="checkbox"/>	IQ:QUAD 4 DEG
Switching off I/Q-impairment	SHIFT <input type="checkbox"/> SPECIAL	3 0 2	ENTER <input type="checkbox"/>	IQ:IMPAIR:OFF

Display:

Carrier leakage

10 %

I > Q

-5 %

Quadrature offset

4.00

The value of the parameter last entered is shown in the MODULATION display. In the case of I > Q the display of the 0.1%-position is suppressed for values higher than 10 %.

Related instructions:

Modulation, I/Q
 Modulation, GMSK
 Modulation, GFSK
 Modulation, $\pi/4$ DQPSK
 Special functions

2.3.25 Modulation, GMSK (Option GMSK Coder)

The SMHU58 is able to perform GMSK modulation (Gaussian Minimum Shift Keying) provided that it is equipped with the option GMSK coder. It generates from a serial data signal the filtered analog signals for control of the I/Q modulator. The I/Q signals generated in the coder are available at the I/Q sockets.

RF range: 10 MHz to 1900 MHz, settable from 1 MHz to 2000 MHz

Data input: Serial, TTL

Clock input: 270.833 kHz, TTL

Settable filtering:	No.	Modulation,	Filter
	1	GMSK,	$B \times T = 0.2$
	2	GMSK,	$B \times T = 0.25$
	3	GMSK,	$B \times T = 0.3$
	4	GMSK,	$B \times T = 0.4$
	5	GMSK,	$B \times T = 0.5$
	6	GMSK,	$B \times T = 0.7$
	7	GMSK,	$B \times T = 1$
	8	not occupied	
	9	MSK, 3 dB-bandwidth 0.7 MHz	
	10	TFM	
	11	not occupied	
	12	not occupied	
	13	not occupied	
	14	Test modulation, no excursion ($\Delta f = 0$)	
	15	Test modulation, pos. excursion ($\Delta f = + 67$ kHz)	

The inputs DATA and CLOCK are situated at the rear of the instrument. The polarity of the active clock edge and that of the GMSK-modulation can be inverted by way of special functions. If the special function is switched off, the positive clock edge is active and modulation excursion is positive with the data signal HIGH.

Special function "Neg. clock edge active": Activating code: 309
Deactivating code: 310

Special function "Digital modulation inverted": Activating code: 313
Deactivating code: 314

The input data can be coded in accordance with the GSM-specification using the special function "GSM difference coding on". If the special function is selected, two successive data bits d_i and d_{i-1} are coded according to the following table (Difference coding on).

GSM difference coding on

d_i	d_{i-1}	Modulation
0	0	+
0	1	-
1	0	-
1	1	+

GSM difference coding off

d_i	Modulation
0	-
1	+

+ $\hat{=}$ pos. modulation excursion
 - $\hat{=}$ neg. modulation excursion

Special function "GSM difference coding on": Activating code: 311
 Deactivating code: 312

Pseudo random binary sequences (PRBS) can be produced internally using the special functions "PRBS generator 9 bit" and "PRBS generator 15 bit". The length of the sequence is either $2^9 - 1$ or $2^{15} - 1$. If the special function is selected, the BNC-sockets identified by DATA and CLOCK are connected such that they have the function of outputs. The output level is HCMOS.

Special function "PRBS generator 9 bit": Activating code: 305
 Deactivating code: 306

Special function "PRBS generator 15 bit": Activating code: 307
 Deactivating code: 308

Example	Entry			IEC-bus code
Switching on GMSK with stored filter	SPECIAL MOD. MODES	DATA	ENTER/UNITS	DM:ON
	DM <input type="text"/>			
Setting filter No. 3	DM <input type="text"/>	3	ENTER <input type="text"/>	DM:FILTER 3
Switching off GMSK	SHIFT <input type="text"/> DM <input type="text"/>			DM:OFF

Display:

If GMSK is selected, it is shown by the illuminated LED of the DM key and additionally by the modulation display as follows:

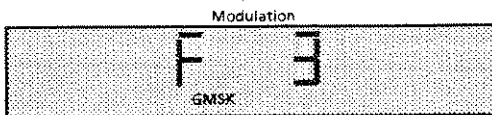

The filter number can be identified by the supplement "F" in the digital display.

If AM, FM or Φ M and GMSK are simultaneously selected, the value of the parameter last entered is displayed.

Note:

With GMSK modulation - as well as with I/Q modulation - I/Q-impairment can be switched on (cf. section I/Q-impairment). In this case continuous level control is automatically replaced by sample and hold mode "AGC off" (cf. section "Modulation, IQ").

Note that in the case of GMSK modulation in combination with pulse modulation delay time in the GMSK modulator is 13 μ s.

GMSK modulation cannot be set simultaneously with:

- Broadband-AM
- Broadband-FM
- I/Q modulation

Related instructions:

- Modulation, I/Q
- I/Q-impairment
- Special functions

2.3.26 Modulation, GFSK (Option DECT Coder)

Equipped with the option DECT coder the SMHU58 is able to perform GFSK modulation (Gaussian Frequency Shift Keying). The DECT coder produces from a serial data signal the filtered analog signals for control of the I/Q modulator. The I/Q signals generated in the coder are available at the I/Q sockets.

RF range: 10 MHz to 1900 MHz, settable from 1 MHz to 2000 MHz

Data input: Serial, TTL

Clock input: 1152 kHz, TTL

Settable filtering:	No.	Modulation,	Filter
	1	not assigned	
	2	GFSK,	B x T = 0.3
	3	GFSK,	B x T = 0.4
	4	GFSK,	B x T = 0.45
	5	GFSK,	B x T = 0.5
	6	GFSK,	B x T = 0.55
	7	GFSK,	B x T = 0.6
	8	GFSK,	B x T = 0.7
	9	MSK,	3 dB bandwidth 3 MHz
	10	not assigned	
	11	not assigned	
	12	not assigned	
	13	not assigned	
	14	Test modulation, no excursion ($\Delta f = 0$)	
	15	Test modulation, pos. excursion ($\Delta f = + 288$ kHz)	

The inputs DATA and CLOCK are situated at the rear of the instrument. The polarity of the active clock edge and that of GFSK modulation can be inverted using special functions. With the special function being switched off the positive clock edge is active and with the data signal HIGH the modulation excursion is positive.

Special function "Neg. clock edge active": Activating code: 309
Deactivating code: 310

Special function "Digital modulation inverted": Activating code: 313
Deactivating code: 314

Pseudo random binary sequences (PRBS) can be generated internally by way of the special functions "PRBS generator 9 bit" and "PRBS generator 15 bit". The length of the sequence is $2^9 - 1$ or $2^{15} - 1$. With the special function switched on the BNC-sockets identified by DATA and CLOCK are connected such that they have the functions of outputs. The output level is HCMOS.

Special function "PRBS generator 9 bit": Activating code: 305
Deactivating code: 306

Special function "PRBS generator 15 bit": Activating code: 307
Deactivating code: 308

Example	Entry			IEC bus code
Switching on GFSK with stored filter	SPECIAL MOD. MODES DM <input type="checkbox"/>	DATA	ENTER/UNITS	DM:ON
Setting filter No. 5	DM <input type="checkbox"/>	5	ENTER <input type="checkbox"/>	DM:FILTER 5
Switching off GFSK	SHIFT <input type="checkbox"/> DM <input type="checkbox"/>			DM:OFF

Display:

If GFSK is switched on, it is indicated both by the illuminated LED of the DM key and in the MODULATION display as follows:

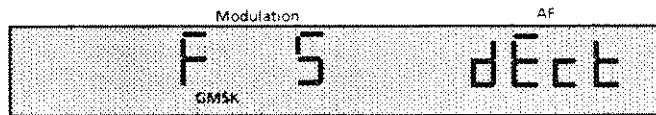

The filter number can be identified by the supplement "F" in the digital display.

If AM, FM or Φ M and GFSK are simultaneously selected, the value of the parameter last entered is displayed.

Note:

With GFSK modulation - as well as with I/Q modulation - I/Q-impairment can be switched on (cf. section I/Q-impairment). In this case continuous level control is automatically replaced by sample and hold mode "AGC off" (cf. section "Modulation, IQ").

In the case of DECT modulation in combination with pulse modulation note that delay time in the DECT modulator is 2.5 μ s.

GFSK modulation cannot be set simultaneously with:

- Broadband AM
- Broadband FM
- I/Q modulation

Related Instructions:

- Modulation, I/Q
- I/Q impairment
- Special functions

2.3.27 Modulation, $\pi/4$ DQPSK (Option ADC Coder)

Fitted with the option ADC coder the SMHU58 is able to perform $\pi/4$ DQPSK modulation ($\pi/4$ shifted, differential encoded quadrature phase shift keying) in accordance with ADC (American Digital Cellular) and JDC (Japanese Digital Cellular). The ADC coder generates from a serial data signal the filtered analog signals for control of the I/Q modulator. The I/Q signals generated in the coder are available at the I/Q sockets.

RF range: 10 MHz to 1900 MHz, settable from 1 MHz to 2000 MHz

RF level: - 140 to + 10 dBm (0.02 μ V to 0.7 V), settable up to 19 dBm

In the case of $\pi/4$ DQPSK modulation the RF level indicated is the rms value of the RF power with a PRBS data source ($2^0 - 1$ or $2^{15} - 1$) and the filter No. 3.

Slight deviations occur with other filterings..

Data input: Serial, TTL

Clock input: Can be switched from bit timing to symbol timing and vice versa for ADC and JDC

Clock	Bit timing	Symbol timing
ADC	48.6 kHz	24.3 kHz
JDC	42 kHz	21 kHz

Settable filtering:	No.	Filter	Roll-off factor
	1	Square root raised cosine	0.25
	2	Square root raised cosine	0.3
	3	Square root raised cosine	0.35
	4	Square root raised cosine	0.4
	5	Square root raised cosine	0.45
	6	Square root raised cosine	0.5
	7	Square root raised cosine	0.55
	8	Square root raised cosine	0.7
	9	cosine	0.25
	10	cosine	0.35
	11	cosine	0.5
	12	cosine	0.7
	13		
	14	Test modulation, no excursion	
	15		

The input data are coded differentially in line with the ADC specification. Two successive data bits X_K and Y_K (symbol) lead to a phase shift $\Delta\Phi$ of the carrier according to the following table:

X_K	Y_K	$\Delta\Phi$
0	0	$\pi/4$
0	1	$3\pi/4$
1	0	$-\pi/4$
1	1	$-3\pi/4$

$X_K \equiv$ all uneven bits (1, 3, 5, ...) $Y_K \equiv$ all even bits (2, 4, 6, ...)

To have a clear relation between the data bits and X_K or Y_K it is possible to switch the CLOCK input/output from bit timing to symbol timing using a special function.

Special function "Symbol timing": Activating code: 321
Deactivating code: 322

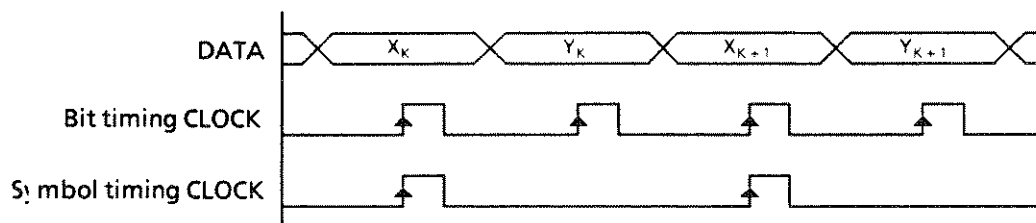

The inputs DATA and CLOCK are located at the rear of the instrument. The polarity of the active clock edge and that of the modulation can be inverted by way of special functions. With the special function switched off the positive clock edge is active.

Special function "Neg. clock edge active": Activating code: 309
Deactivating code: 310

Special function "Digital modulation inverted": Activating code: 313
Deactivating code: 314

Bit timing or symbol timing can be switched from ADC to JDC using the special function "JDC bit rate".

Special function "JDC bit rate": Activating code: 323
Deactivating code: 324

Pseudo random binary sequences (PRBS) can be produced internally using the special functions "PRBS generator 9 bit" and "PRBS generator 15 bit". The length of the sequence is either $2^9 - 1$ or $2^{15} - 1$. If the special function is selected, the BNC-sockets identified by DATA and CLOCK are connected such that they have the function of outputs. The output level is HCMOS.

Special function "PRBS generator 9 bit": Activating code: 305
Deactivating code: 306

Special function "PRBS generator 15 bit": Activating code: 307
Deactivating code: 308

Example	Entry			IEC bus code
Switching on $\pi/4$ DQPSK with stored filter	SPECIAL MOD. MODES	DATA	ENTER/UNITS	DM:ON
	DM <input type="checkbox"/>			
Setting filter No. 3	DM <input type="checkbox"/>	3	ENTER <input type="checkbox"/>	DM:FILTER 3
Switching off $\pi/4$ DQPSK	SHIFT <input type="checkbox"/> DM <input type="checkbox"/>			DM:OFF

Display:

When $\pi/4$ DQPSK is switched on, it is indicated by the illuminated LED of the DM key and furthermore in the modulation display as follows:

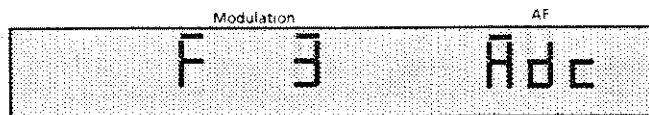

The filter number can be identified by the supplement "F" in the digital display.

When the special function "JDC bit rate" is switched on, "JDC" instead of "ADC" can be read off in the AF display

If FM or Φ M and DM are simultaneously selected, the value of the parameter last entered is displayed.

Note:

With $\pi/4$ DQPSK modulation - as well as with I/Q modulation - continuous level control is automatically replaced by sample and hold mode "AGC off" (cf. section "Modulation, IQ").

Note that in the case of $\pi/4$ DQPSK modulation in combination with pulse modulation delay time in the ADC coder is about 185/230 μ s (ADC/JDC).

$\pi/4$ DQPSK modulation cannot be set simultaneously with:

- AM, Broadband AM
- Broadband FM
- I/Q modulation

Related Instructions:

- Modulation, I/Q
- I/Q impairment
- Special functions

2.3.28 Modulation, $\pi/4$ DQPSK (Option CT Coder)

Fitted with the option CT coder the SMHU58 is able to perform $\pi/4$ DQPSK modulation ($\pi/4$ shifted, differential encoded quadrature phase shift keying) in accordance with JCT (Japanese Cellular Telephone). The CT coder generates from a serial data signal the filtered analog signals for control of the I/Q modulator. The I/Q signals generated in the coder are available at the I/Q sockets.

RF range: 10 MHz to 1900 MHz, settable from 1 MHz to 2000 MHz

RF level: - 140 to + 10 dBm (0.02 μ V to 0.7 V), settable up to 19 dBm

In the case of $\pi/4$ DQPSK modulation the RF level indicated is the rms value of the RF power with a PRBS data source ($2^0 - 1$ or $2^{15} - 1$) and the filter No. 2.

Slight deviations occur with other filterings..

Data input: Serial, TTL

Clock input: Can be switched from bit timing to symbol timing and vice versa

Bit timing = 384 kHz

Symbol timing = 192 kHz

Settable filtering:	No.	Filter	Roll-off factor
	1	Square root raised cosine	0.45
	2	Square root raised cosine	0.5
	3	Square root raised cosine	0.55
	4	cosine	0.45
	5	cosine	0.5
	6	cosine	0.55

The input data are coded differentially in line with the JCT specification. Two successive data bits X_K and Y_K (symbol) lead to a phase shift $\Delta\Phi$ of the carrier according to the following table:

X_K	Y_K	$\Delta\Phi$
0	0	$\pi/4$
0	1	$3\pi/4$
1	0	$-\pi/4$
1	1	$-3\pi/4$

$X_K \equiv$ all uneven bits (1, 3, 5, ...) $Y_K \equiv$ all even bits (2, 4, 6, ...)

To have a clear relation between the data bits and X_K or Y_K it is possible to switch the CLOCK input/output from bit timing to symbol timing using a special function.

Special function "Symbol timing": Activating code: 321
Deactivating code: 322

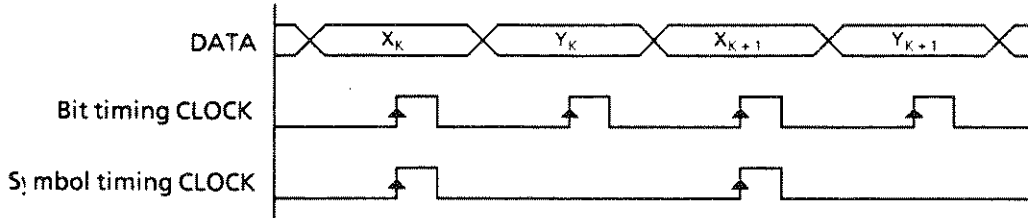

The inputs DATA and CLOCK are located at the rear of the instrument. The polarity of the active clock edge and that of the modulation can be inverted by way of special functions. With the special function switched off the positive clock edge is active.

Special function "Neg. clock edge active": Activating code: 309
Deactivating code: 310

Special function "Digital modulation inverted": Activating code: 313
Deactivating code: 314

Pseudo random binary sequences (PRBS) can be produced internally using the special functions "PRBS generator 9 bit" and "PRBS generator 15 bit". The length of the sequence is either $2^9 - 1$ or $2^{15} - 1$. If the special function is selected, the BNC-sockets identified by DATA and CLOCK are connected such that they have the function of outputs. The output level is HCMOS.

Special function "PRBS generator 9 bit": Activating code: 305
Deactivating code: 306

Special function "PRBS generator 15 bit": Activating code: 307
Deactivating code: 308

Example	Entry			IEC bus code
	SPECIAL MOD. MODES	DATA	ENTER/UNITS	
Switching on $\pi/4$ DQPSK with stored filter	DM <input type="checkbox"/>			DM:ON
Setting filter No. 2	DM <input type="checkbox"/>	2	ENTER <input type="checkbox"/>	DM:FILTER 2
Switching off $\pi/4$ DQPSK	SHIFT <input type="checkbox"/> DM <input type="checkbox"/>			DM:OFF

Display:

When $\pi/4$ DQPSK is switched on, it is indicated by the illuminated LED of the DM key and furthermore in the modulation display as follows:

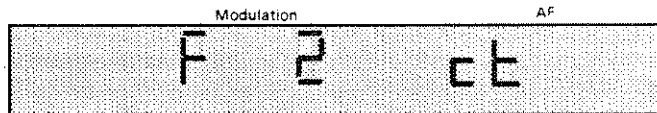

The filter number can be identified by the supplement "F" in the digital display.

If FM or Φ M and DM are simultaneously selected, the value of the parameter last entered is displayed.

Note:

With $\pi/4$ DQPSK modulation - as well as with I/Q modulation - continuous level control is automatically replaced by sample and hold mode "AGC off" (cf. section "Modulation, IQ").

Note that in the case of $\pi/4$ DQPSK modulation in combination with pulse modulation delay time in the CT coder is about 19 μ s.

$\pi/4$ DQPSK modulation cannot be set simultaneously with:

- AM, Broadband AM
- Broadband FM
- I/Q modulation

Related Instructions:

- Modulation, I/Q
- I/Q impairment
- Special functions

2.3.29 Modulation, External Source

Modulation inputs AM EXT and FM/ Φ M EXT are available for externally applied modulation.

The two modulation inputs can be ac-or dc-coupled for modulation modes AM and FM. The coupling is selected using key EXT AC or key EXT DC in the MODE keypad.

Both inputs are factory-set to input impedances of 100 k Ω .

The input impedances can be changed to 600 Ω using internal plug-in jumpers, which are fitted with the AF generator module (819.3260).

The jumper positions are as follows:

Input impedance	FM / Φ M	AM
100 k Ω	X2 / 2-3	X3 / 2-3
600 Ω	X2 / 1-2	X3 / 1-2

A signal of $V_p = 1$ V ($V_{rms} = 0.707$ V) is required to be applied to obtain the deviation and modulation depth accuracies guaranteed in the enclosed Data Sheet.

Any deviations from the required input voltage are indicated in the MODULATION display by EXT LOW or EXT HIGH.

"EXT LOW" is read out with voltages $V_p < 0.97$ V, "EXT HIGH" with voltages $V_p > 1.03$ V. An external voltmeter must be used if greater accuracy is required.

Information on FM DC:

FM DC mode allows for VCO operation, externally applied analog sweeps or digital frequency modulation.

Modulation frequency: dc to 100 kHz
 Deviation (depending on the carrier frequency): 0 to 3200 kHz
 Tuning voltage: -1 V to +1 V

The tuning range is determined by the entered deviation. A range of -1 V to +1 V corresponds to a frequency increment of RF frequency minus deviation to RF frequency plus deviation.

The generator output signal is not phase-synchronized in FM DC mode.

Information on AM DC:

AM DC mode allows for external level control and digital amplitude modulation.

Modulation frequency: dc to 50 kHz
 Modulation depth: 0 to 100%
 Input voltage: -1 V to +1 V

The level variation range is determined by the entered modulation depth. A range from -1 V to +1 V corresponds to a change in level between level $0_V \cdot (1-m)$ and level $0_V \cdot (1+m)$.

Level 0_V is the RF level entered numerically in V.

The maximal range, e.g. for maximal carrier blanking, is reached at $m = 100\%$.

Related instructions: Modulation, AM
 Modulation, FM
 Modulation, two-tone
 Modulation, FSK
 Modulation, AM SQU

2.3.31 Rotary Knob Variation

The rotary knob for variation is useful for fast sweeps over wide ranges as well as for small variations with a fine step size.

The parameters to be varied by the rotary knob are RF/CF, AF, LEV RF, LEV AF, as well as the modulation depth with AM and the deviation with FM or Φ M. However, the rotary knob cannot be used for variation of the SHIFT parameters, such as RF OFFSET, or for the sweep parameters.

Generally (except HOLD mode is selected), the rotary knob function varies the parameter which is currently set (respective LED in PARAMETER keypad illuminated). The knob variation function is automatically transferred to any newly selected parameter, in which case the step size last selected for this particular parameter is assumed by the instrument.

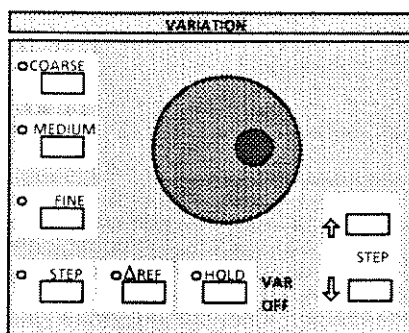

In HOLD mode, the variability function is fixed to the parameter that was set upon actuation of the HOLD key. This parameter then remains variable as long as the HOLD key is pressed, even if different parameters are subsequently selected (see section "HOLD Variation").



Operation: Clockwise rotation increases the value of the set parameter, counterclockwise rotation decreases it.

Deactivating the knob function: SHIFT — VAR OFF

Activating the knob function: Press one of the 4 step size keys COARSE, MEDIUM, FINE or STEP if a variable parameter is currently selected and no manual sweep is set.

Example	Entry
Deactivating the rotary knob	<p style="text-align: center;">VARIATION</p> <div style="display: flex; justify-content: space-around; align-items: center;"> <div style="text-align: center;"> <p>SHIFT</p>  </div> <div style="text-align: center;">  <p>VAR OFF</p> </div> </div>

The rotary knob function cannot be programmed. To allow programming of the stepped variation, the VARIATION STEP function has been provided (see section "Variation, STEP").

LED display: The rotary knob function is available for use if one of the LEDs of step size keys COARSE, MEDIUM, FINE or STEP is illuminated.

Related instructions: Rotary knob variation, step size
 Variation, Δ REF
 Variation, HOLD
 Variation, STEP
 Manual sweep

2.3.32 Rotary Knob Variation, Step Size

The size of the stepped rotary knob variation is set by means of keys FINE, MEDIUM or COARSE (fixed step sizes), or by means of the STEP key (selectable step size).

The stepped knob variations for the individual parameters are as follows:

Parameter	FINE	MEDIUM	COARSE
RF / CF	1 Hz	1 kHz	1 MHz
AF	1 Hz	10 Hz	100 Hz
LEV RF	0.1 dB	1 dB	10 dB
LEV AF	0.2 mV	2 mV	20 mV
AM	0.1 %	1%	10%
FM	10 Hz	100 Hz	1 kHz
Φ M	0.001 rad	0.01 rad	0.1 rad
BB-FM	1 kHz	10 kHz	100 kHz
Phase offset	1 deg	5 deg	10 deg
CARR LEAK	1 %	-	-
I > Q	0.1 %	-	-
QUAD OFFSET	0.1 degree	-	-

The step size of the rotary knob is switched over to the freely selectable STEP size by pressing the STEP key in the VARIATION keypad. For each parameter, its individual STEP size value may be entered, which remains stored when the parameter is changed. (For STEP size entries, see section "Variation, STEP").

As soon as a new parameter is set in the PARAMETER keypad, the generator automatically assumes the step size used last for this particular parameter (unless HOLD mode is set).

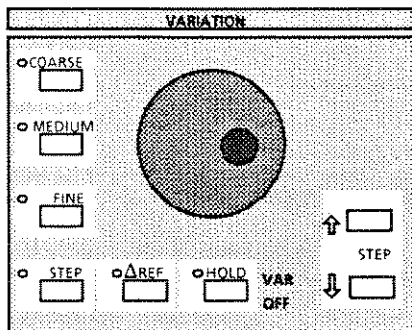

VARIATION keypad

Selecting the step size: by pressing one of the 4 keys COARSE, MEDIUM, FINE or STEP

Indication of step size: by LEDs of step size keys

Related instructions: Rotary knob variation
Variation, Δ REF
Variation, HOLD
Variation, STEP

2.3.33 Variation, HOLD

The HOLD function allows that the knob variation function is not automatically transferred to the newly selected parameter, but the parameter selected upon actuation of the HOLD key remains variable.

Switching on the HOLD function:	HOLD key in the VARIATION keypad with the variation switched on
Switching off the HOLD function:	By pressing HOLD key again or using key sequence: SHIFT ____ VAR OFF
LED display:	LED of HOLD key illuminated
Related instructions:	Rotary knob variation Rotary knob variation, step size Variation, Δ REF Variation, STEP

2.3.34 Variation, Δ REF

The Δ REF variation function features the possibility that instead of the value currently set for the variable parameter, the difference between the set value and the reference value is displayed. The reference value is the parameter value entered upon actuation of the Δ REF key.

Switching on the Δ REF function:	Δ REF key in the VARIATION keypad with the variation switched on.
Switching off the Δ REF function:	by pressing one of the parameter keys (HOLD function not set) or using key sequence: SHIFT ____ VAR OFF
Display:	LED of Δ REF key illuminated and " Δ " output in the display of the currently selected variable parameter.
Related instructions:	Rotary knob variation Rotary knob variation, step size Variation, HOLD Variation, STEP

2.3.35 Variation, STEP

The VARIATION STEP function allows for parameters to be incremented or decremented in freely selectable steps. The variation always applies to the currently set parameter (respective LED illuminated).

Parameters to be varied are RF/CF, AF, LEV RF, LEV AF, as well as the modulation depth with AM and the deviation with FM or Φ M. The SHIFT parameters, such as for example RF OFFSET, and the sweep parameters cannot be varied.

An individual STEP size can be entered for each parameter, which remains stored in the instrument when another parameter is selected.



STEP variation is effected by pressing the STEP \uparrow \downarrow keys in the VARIATION keypad or by rotating the knob following selection of STEP.



Holding down the STEP \uparrow \downarrow keys has the effect that the STEP variation takes place repeatedly.

The STEP \uparrow \downarrow keys are always activated as long as a parameter is set.

Setting the STEP size:

Parameter _____ V-STEP _____ Data _____ Unit _____

For any new selection of the STEP size, the V-STEP key is pressed again. Actuating of the parameter key is not required if the parameter is already set (respective LED illuminated).

The smallest STEP sizes for the various parameters are:

RF/CF	0.1 Hz
AF	1 Hz
LEV RF	0.1 dB
LEV AF	0.2 mV
AM	0.1 %
FM	10 Hz
Φ M	0.001 rad
Phase offset	1 deg

The STEP size of the level must always be entered in dB, even if mV or μ V is currently selected as level unit.

Example	Entry			IEC bus code	
	PARAMETER	DATA	ENTER/UNITS		
Setting RF STEP size 25 kHz	RF/CF <input type="checkbox"/>	V-STEP <input type="checkbox"/>	<input type="text" value="2"/> <input type="text" value="5"/>	kHz <input type="checkbox"/>	RF:VAR 25 KHZ
Setting level STEP size 3 dB	lev rf <input type="checkbox"/>	V-STEP <input type="checkbox"/>	<input type="text" value="3"/>	<input type="checkbox"/> dB	LEV:RF:VAR 3DB

Display:

Any newly selected STEP size is read out in the display of the currently set parameter until the entry is terminated by unit key. Then the display again reads out the set parameter value.

To have the STEP size for a parameter displayed, the V-STEP key in the PARAMETER keypad is pressed with the parameter set (respective parameter LED illuminated).

Related instructions:

Rotary knob variation
Rotary knob variation, step size

2.3.36 Heterodyne Band 125 MHz

If this special function is activated the heterodyne band 0.1 to 125 MHz is used for frequency generation instead of the partial ranges up to 125 MHz. This function allows for higher deviations in the frequency range up to 125 MHz with FM and Φ M. In the case of the heterodyne band range, however, the quality of frequency generation is less good on account of increased spurious and phase noise.

Band	Frequency range [MHz]	Max. FM deviation [kHz]	Max. Φ M deviation [rad]	Factor
9	2160 to 4320	3200	320	0.5
8	1000 to 2160	1600	160	1
7	500 to 1000	800	80	2
6	250 to 500	400	40	4
5	125 to 250	200	20	8
4	62.5 to 125	100	10	16
3	31.25 to 62.5	50	5	32
2	15.625 to 31.25	25	2.5	64
1	0.1 to 15.625	200	20	8
Heterodyne band 125 MHz	0.1 to 125	800	80	2

Special function "Heterodyne Band 125 MHz":

Activating code: 21

Deactivating code: 22

Related instructions:

Frequency (RF)
Modulation, FM, Φ M
Special functions

2.3.37 Sweep

The Signal Generator features digital, stepwise sweep for RF, AF, LEV RF and memory (MEM). This means that using the sweep function the change in frequency is effected in selectable steps rather than in a continuous analog manner.

The sweep parameters START, STOP, SPAN, STEP, TIME/STEP and MARKER are determined by numeric entries.

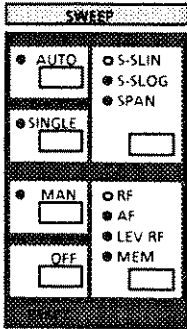

SWEEP keypad

The keys in the SWEEP keypad are used to select the currently required operating mode. The following operating modes are available:

- **AUTO** Sweep from a start end-point to a stop end-point with automatic restart at the end of each sweep.
- **SINGLE** Single sweep from the start end-point to the stop end-point.
- **MAN** Manual sweep using the rotary knob within the sweep limits.
- **S-S LIN** Linear start-stop sweep.
- **S-S LOG** Logarithmic start-stop sweep.
- **SPAN** Sweep centered round the center frequency (CF/RF) with freely selectable sweep span (SPAN).
- **RF** RF sweep.
- **AF** AF sweep.
- **LEV RF** RF level sweep.
- **MEM** Memory sweep.

The outputs X-AXIS, Z-AXIS and MARKER located at the rear of the instrument are fitted for controlling and triggering oscilloscopes or XY recorders (see section "Sweep outputs").

2.3.38 Sweep, RF

The LED of the RF key in the SWEEP keypad is illuminated when the RF sweep is switched on. To select the sweep mode, its respective key is pressed.

Activating the sweep: by pressing one of the keys AUTO, SINGLE or MAN.

Deactivating the sweep: by pressing the OFF key in the SWEEP keypad.

Sweep performance is indicated by means of the LED of the AUTO, SINGLE or MAN mode currently used (LED illuminated). The LEDs indicating the selected sweep mode (e.g. S-S LIN and RF) are illuminated also if the sweep is switched off.

The following sweep modes are available:

- **S-S LIN** Linear start-stop sweep.
- **S-S LOG** Logarithmic start-stop sweep.
- **SPAN** Sweep centered round the center frequency (CF/RF) with freely selectable sweep span (SPAN).

Setting ranges of RF sweep parameters:

Sweep parameter	Setting range	Resolution
Start, Stop	100 kHz to 4320 MHz	0.1 Hz
SPAN	0.2 Hz to 4319.9 MHz	0.1 Hz
STEP (lin)	0.1 Hz to 4319.9 MHz	0.1 Hz
STEP (log)	0.01% to 50%	0.01%
TIME / STEP	10 ms to 10 s	1 ms
MARKER	100 kHz to 4320 MHz	0.1 Hz

Display: The operating mode is indicated by the illuminated LEDs in the SWEEP keypad. The FREQUENCY-RF/CF display reads out the current sweep frequency.

Related instructions: Sweep parameter entry
Sweep operating modes
Sweep, Start-Stop (LIN, LOG)
Sweep, Span
Sweep, Marker
Sweep outputs

2.3.39 Sweep, AF

The LED of the AF key in the SWEEP keypad is illuminated when the AF sweep is switched on. To select the sweep mode, its respective key is pressed.

AF sweep can be used also for sweeping the modulation frequency with internal modulation. In this case, internal modulation and AF sweep must be switched on simultaneously. Note the modulation frequency ranges with AM, FM and Φ M.

Activating the sweep: by pressing one of the keys AUTO, SINGLE or MAN.

Deactivating the sweep: by pressing the OFF key in the SWEEP keypad.

Sweep performance is indicated by means of the LED of the AUTO, SINGLE or MAN mode currently used (LED illuminated). The LEDs indicating the selected sweep mode (e.g. S-S LIN and AF) are illuminated also if the sweep is switched off.

The following sweep modes are available with AF sweep:

- **S-S LIN** Linear start-stop sweep.
- **S-S LOG** Logarithmic start-stop sweep.

Setting ranges of AF sweep parameters:

Sweep parameter	Setting range	Resolution
Start, Stop	1 Hz to 100 kHz	1 Hz
STEP (lin)	1 Hz to 99.99 kHz	1 Hz
STEP (log)	0.01% to 50%	0.01%
TIME / STEP	10 ms to 10 s	1 ms
MARKER	1 Hz to 100 kHz	1 Hz

Display: The operating mode is indicated by the illuminated LEDs in the SWEEP keypad. The AF display reads out the current sweep frequency.

Related instructions: Sweep parameter entry
Sweep operating modes
Sweep, Start-Stop (LIN, LOG)
Sweep, Marker
Sweep outputs

2.3.40 Sweep, LEV RF

The LED of the LEV RF key in the SWEEP keypad is illuminated when level sweep is selected. To select the sweep mode, its respective key is pressed.

Activating the sweep: by pressing one of the keys AUTO, SINGLE or MAN.

Deactivating the sweep: by pressing the OFF key in the SWEEP keypad.

Sweep performance is indicated by means of the LED of the AUTO, SINGLE or MAN mode currently used (LED illuminated). The LEDs indicating the selected sweep mode (e.g. S-S LOG and LEV RF) are illuminated also if the sweep is switched off.

In LEV RF mode of the generator, only logarithmic start-stop sweep (S-S LOG) is available.

The level sweep may cover a maximal range of 20 dB. If this permissible range is exceeded, the over-range error code "11" is displayed.

Setting ranges of level sweep parameters:

Sweep parameter	Setting range	Resolution
Start, Stop	-140 dBm to 13 dBm	0.1 dB
STEP	0.1 dB to 20 dB	0.1 dB
TIME / STEP	10 ms to 10 s	1 ms
MARKER	-140 dBm to 13 dBm	0.1 dB

Display: The operating mode is indicated by the illuminated LEDs in the SWEEP keypad. The LEVEL display reads out the current sweep level.

Note: Level sweep cannot be set in combination with:
Pulse modulation
Special function "AGC off"

Related instructions: Sweep parameter entry
Sweep operating modes
Sweep, Start-Stop
Sweep, Marker
Sweep outputs

2.3.41 Sweep, Memory (MEM)

In memory sweep mode, stored instrument settings can be recalled in upward or downward sequence. If MAN mode is used, the memory addresses are called up with the STEP ↑ ↓ keys in the VARIATION keypad instead of using the rotary knob.

The LED of the MEM key in the SWEEP keypad is illuminated when memory sweep is switched on. To select the sweep mode, its respective key is pressed.

Activating the sweep: by pressing one of the keys AUTO, SINGLE or MAN.

Deactivating the sweep: by pressing the OFF key in the SWEEP keypad.

Sweep performance is indicated by means of the LED of the AUTO, SINGLE or MAN mode currently used (LED illuminated). The LEDs indicating the selected sweep mode (e.g. MEM) are illuminated also if the sweep is switched off.

In MEM sweep mode of the generator, only linear start-stop sweep with step size 1 is possible. The MEM sweep cannot be stored.

No STEP or MARKER entries are possible with memory sweep mode. Selection of MEM mode does not affect the sweep outputs X-AXIS, Z-AXIS and MARKER.

Setting ranges of memory sweep parameters:

Sweep parameter	Setting range	Resolution
Start, Stop	Memory 1 to 50	
TIME / STEP	50 ms to 60 s	1 ms

Display: The operating mode is indicated by the illuminated LEDs in the SWEEP keypad. The address of the memory location is read out in the right corner of the LEVEL display. If another sweep (RF, AF or LEV RF) is stored in a stored setting, also the LEDs indicating the mode of this stored sweep (e.g. S-S LIN and RF) are illuminated in addition to the MEM sweep mode LEDs.

Note: *Setting AUTO mode with short step times highly stresses the mechanical attenuator set.*

Related instructions: Sweep parameter entry
Sweep operating modes
Sweep, Start-Stop

2.3.42 Sweep, Fast Mode Memory

Special function "Memory Sweep Fast Mode" switches the memory sweep function to fast mode.

Special function "Memory Sweep Fast Mode": Activating code 45
 Deactivating code 46

The number of memories available varies from 220 to 4801 depending on the respective model of the signal generator (see below).

If memory sweep fast mode is switched on, stored instrument settings can be recalled in upward or downward sequence, with the exception of the attenuation setting. The fast mode setting has no effect on the mechanical attenuator. The attenuation must already be set as required prior to starting the sweep run. If level variation is required in fast mode, this can be obtained in a 20-dB range using the special function "Transient-free Level Settings".

The following applies to SMHU58: The operating modes BB-FM, BB-AM, I/Q and DM cannot be changed in fast mode. Deviation only can be altered in the operating mode BB-FM. Before starting the sweep, the desired operating mode must be switched on.

Activating the sweep: by pressing one of the keys AUTO, SINGLE or MAN.

Deactivating the sweep: by pressing any key except the STEP keys. When switched off, the valid setting prior to sweep start is reassumed in the instrument.

Memory selection in MAN mode by means of:

- positive edge at the TRIGGER input (rear)
- Group Execute Trigger of IEC-Bus
- STEP keys

The sweep parameters (START, STOP, TIME/STEP) are selected as with normal memory sweep mode. Separate sweep parameter data sets and memories are used for the fast mode. In some models fast mode memories and normal memories overlap (cf. table below). Therefore it is possible to overwrite the contents of normal memories although "Memory Sweep Fast Mode" is activated and vice versa. An error message is given out if destroyed memories are called up.

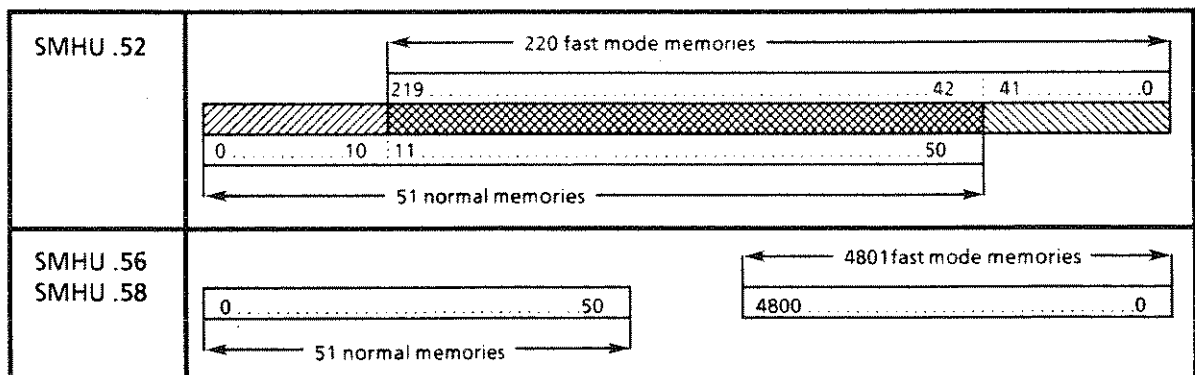

Key sequence STO ___ Data ___ ENTER is used to store instrument settings in fast mode memories. Fast mode memories cannot be recalled by key sequence RCL ___ Data ___ ENTER.

Setting ranges of fast memory sweep parameters:

Sweep Parameter	Setting Range	Resolution
Start, Stop	Memory 0 to 219 (Model .52) Memory 0 to 4800 (Model .56/.58)	
TIME / STEP	1 ms to 60 s	1 ms

Display: If memory sweep fast mode (AUTO, SINGLE or MAN) is switched on, FREQUENCY display reads as follows:

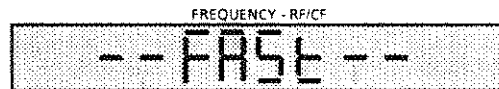

The memory address is shown on the LEVEL display if an internal step time > 3 ms is set.

Note: Approx. 3 ms are required to have the memory address transferred to the LEVEL display. With a step time < 4 ms with external trigger, an internal step time ≤ 3 ms must be set to suppress the display readout.

Signals with memory sweep fast mode:

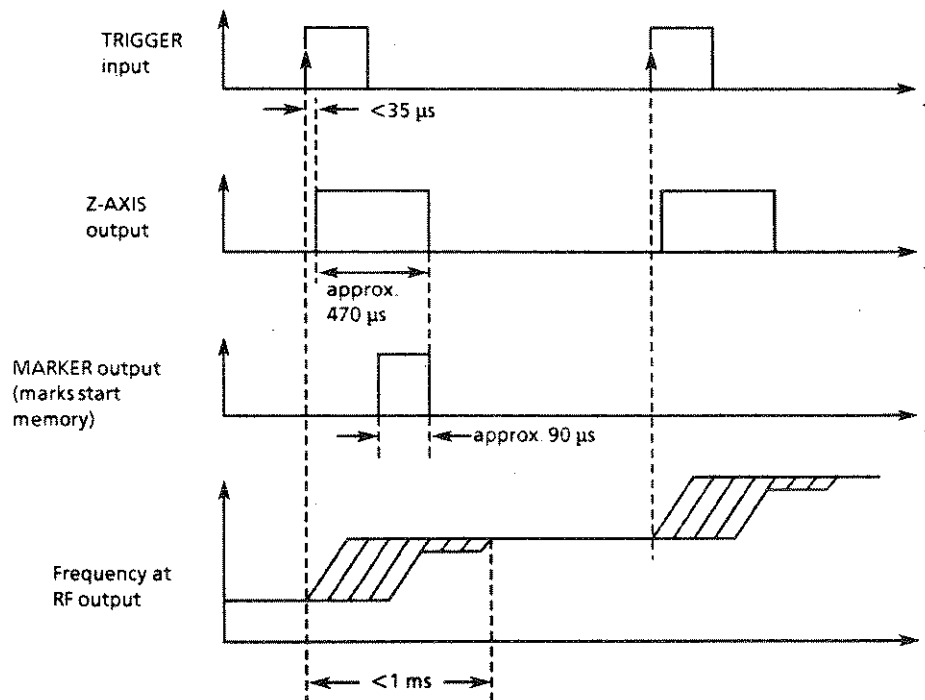

Pulse or AM-SQUARE modulation with the Z-AXIS signal can eliminate transient effects when changing the frequency. In this case pulse or AM-SQUARE modulation must already be activated prior to storing the settings in the fast mode memory.

Related instructions: Sweep, Memory
 Sweep parameter entry
 Sweep, operating modes
 Sweep, Start-Stop
 Special functions

2.3.43 Fast Hop Bus (SMHU .56/.58 only)

In this operating mode the addresses of the fast mode memories can be determined externally as desired within the range of 0 to 4800 (in binary code, 13 bits parallel) via the fast hop bus connection. This makes externally controlled frequency hopping possible. In addition all other signal parameters can be controlled externally (with the exception of the mechanical setting of the precision attenuator).

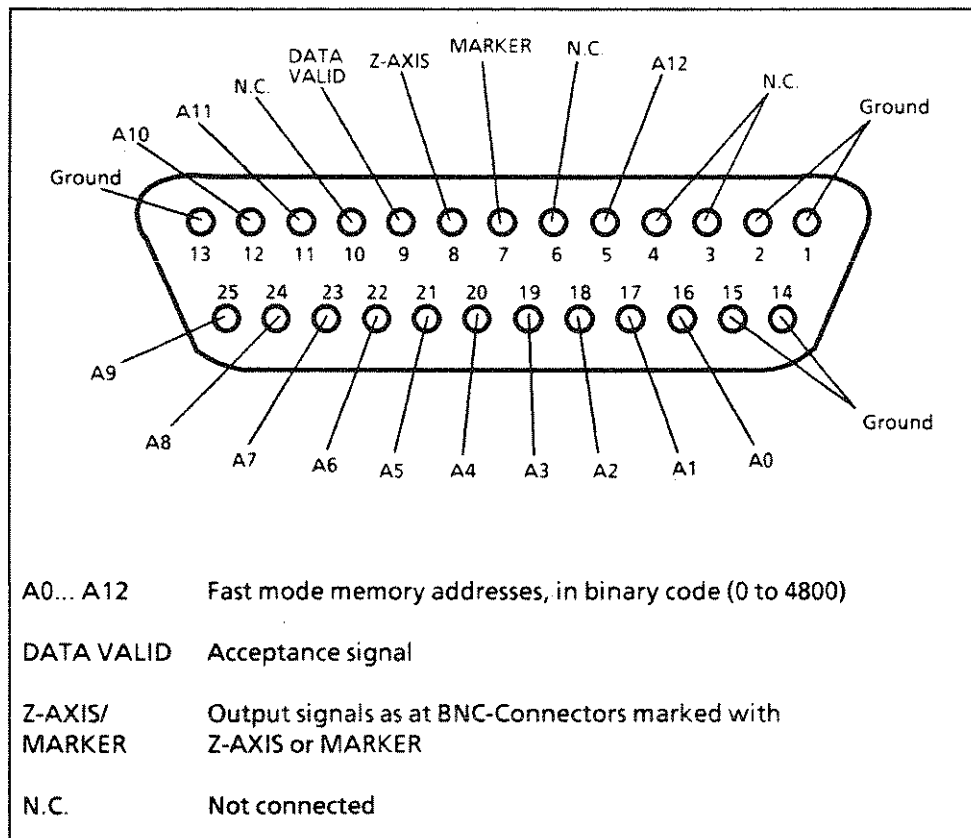

Connector pin assignment of Fast Hop Bus

Operating instructions are similar to those of Memory sweep fast mode:

Special function "Fast Hop Bus" switches memory sweep to fast hop bus mode.

Special function "Fast Hop Bus" : Activating code 47
 Deactivating code 48

Activating the Fast Hop Bus Mode:

Manual operation	IEC-Bus
- SHIFT SPECIAL 47 ENTER - Selecting memory sweep (Control panel SWEEP)	- SWP : MODE : MEMORY : HOP_BUS
- MAN (Control panel SWEEP)	- SWP : MAN

The address is accepted by a positive edge of the DATA VALID signal (at the fast hop bus connection) and the respective setting in the instrument is activated.

Deactivating the Fast Hop Bus Mode:

Manual operation	IEC-Bus
- Pressing OFF (Control panel SWEEP) or any other key	- SWP : OFF or any other command

The valid setting prior to fast hop bus mode is reassumed in the instrument.

The parameter TIME/STEP (IEC-Bus : TIME : MEMORY_SWP : FAST) activates or deactivates the display of the memory address:

TIME/STEP \leq 3 ms Display of the memory address is switched off (in accelerated fast hop bus mode)

TIME/STEP \geq 4 ms Display of the memory address is switched on (minimum time elapsing between two successive data valid signals: 4 ms). Thus easy handling of the fast hop bus control is possible.

TIME/STEP and the other sweep parameters have no other functions in this operating mode.

Display with fast hop bus mode activated:

TIME/STEP \geq 4 ms:

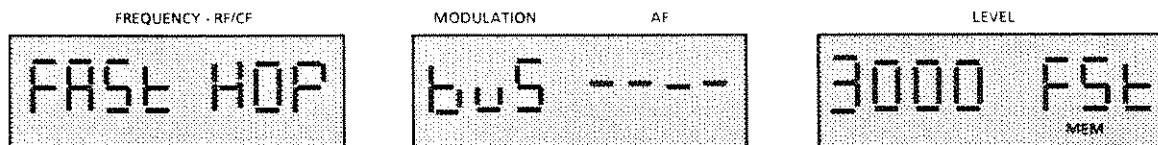

TIME/STEP \leq 3 ms:

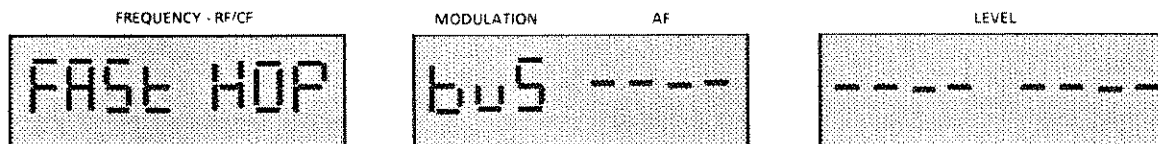

The storage of instrument settings in the fast mode memories is performed in the same way as in memory sweep fast mode:

Manual operation	IEC-Bus
<ul style="list-style-type: none"> - STO memory address ENTER Either special function 47 (Fast hop bus) or 45 (Memory sweep fast mode) must be activated. The fast mode memories can be used in both operating modes. 	<ul style="list-style-type: none"> - STORE : FAST Speicheradresse memory address

Note: Special function 47 (Fast hop bus) and 45 (Memory sweep fast mode) must not be active at the same time, as they deactivate each other.

Signals in fast hop bus mode:

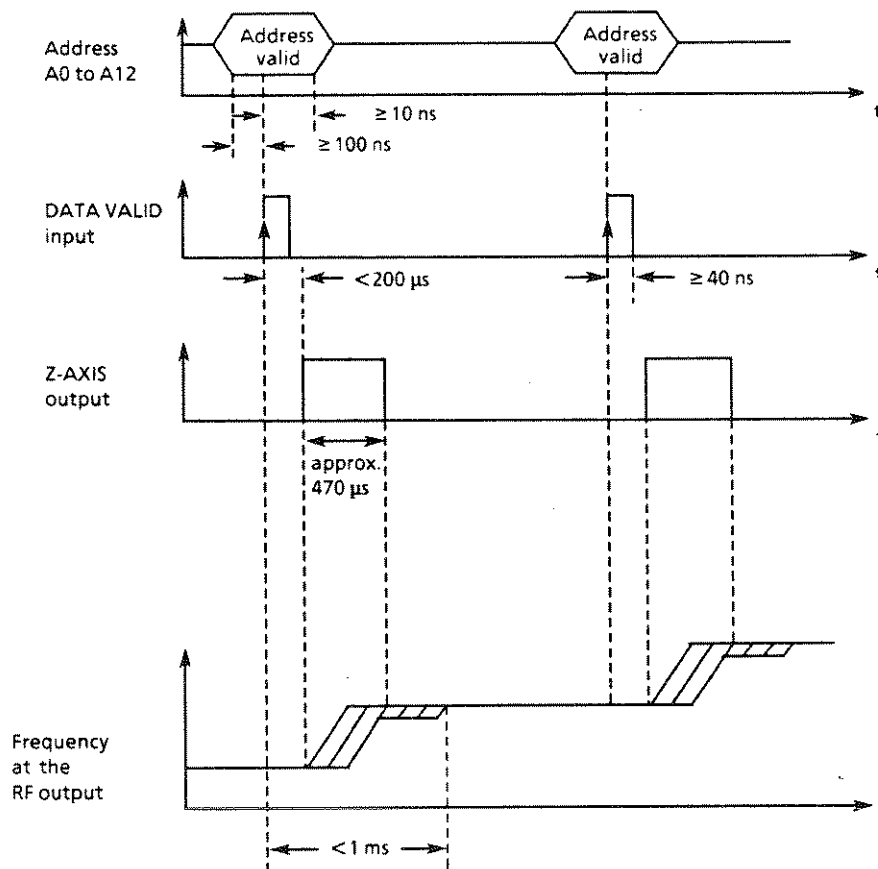

Pulse or AM-SQUARE modulation with the Z-AXIS signal can eliminate transient effects when changing the frequency. In this case pulse or AM-SQUARE modulation must already be activated prior to storing the settings in the fast mode memory.

Related instructions: Sweep, parameter entry
Sweep, operating modes
Special functions

2.3.44 Sweep Parameter Entry

The sweep parameter keys are assigned to the currently valid sweep function which is indicated by means of the sweep LEDs RF, AF, LEV RF and MEM. The parameters to be set are START, STOP, SPAN, STEP, TIME/STEP and MARKER and remain individually stored for each of the sweep functions.

The sweep parameters remain set for one entry only. Variations via rotary knob or STEP ↑ ↓ keys cannot be performed.

The sweep parameters can be entered also if another sweep run is presently performed.

Entry: Sweep parameter ____ Data ____ Unit

Example	Entry			IEC bus code	
	PARAMETER	DATA		ENTER/UNITS	
Entering start frequency 100 MHz	START <input type="text"/>	<input type="text" value="1"/>	<input type="text" value="0"/>	<input type="text" value="0"/> MHz	RF:START 100 MHZ
Entering stop frequency 200 MHz	STOP <input type="text"/>	<input type="text" value="2"/>	<input type="text" value="0"/>	<input type="text" value="0"/> MHz	RF:STOP 200 MHZ
Entering step width 1 MHz	STEP <input type="text"/>		<input type="text" value="1"/>	<input type="text"/> MHz	RF:STEP 1 MHZ
Entering step time 50 ms	TIME/ STEP <input type="text"/>	<input type="text" value="5"/>	<input type="text" value="0"/>	<input type="text"/> msec	TIME:RF 50 MS

Display: The sweep parameters are read out in the respective display, depending on the selected sweep mode, as long as the parameter key is pressed.

During data entry using the DATA keys, the numerals of the new entry are read out progressively.

Related instructions: Sweep, RF, AF, LEV RF, MEM
Sweep, Start-Stop (LIN, LOG)
Sweep, Span
Sweep, Marker

2.3.45 Sweep, Operating Modes

The keys AUTO, SINGLE, MAN and OFF positioned in the SWEEP keypad are used for switching on and off the sweep and for determining the type of sweep to be performed.

Sweep performance of the Generator is indicated by LEDs AUTO, SINGLE or MAN (on).

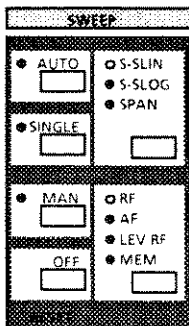

SWEEP keypad

AUTO

1. Pressing the AUTO key with sweep switched off:
 - starts the sweep from the start end-point to the stop end-point with automatic restart from the start end-point.
2. Pressing the AUTO key with sweep switched on:
 - starts the sweep from the current sweep setting with automatic restart after reaching the stop value.

SINGLE

1. Pressing the SINGLE key with sweep switched off:
 - starts a single sweep from the start-end point to the stop end-point.
2. Pressing the SINGLE key with sweep switched on:
 - starts the sweep from the current sweep setting. The sweep automatically stops after reaching the stop end-point.
 - initiates a new sweep from the start end-point if the current setting is identical to the stop end-point.

MAN

Manual sweep using the rotary knob within the sweep limits.

1. Pressing the MAN key with sweep switched off:
 - does not change the current setting if it is within the sweep range.
 - sets the start end-point value if the setting is outside the sweep range.
2. Pressing the MAN key with sweep switched on:
 - interrupts a sweep run at the currently reached setting.

RESET

Pressing SHIFT and RESET sets the start end-point, and MAN sweep operating mode is assumed by instrument.

OFF

Pressing the OFF key

- switches off the start-stop sweep at the currently reached setting.
- switches the span sweep off. The center frequency CF is taken as RF and is set.

Related instructions: Sweep, RF, AF, LEV RF, MEM
 Sweep parameter entry
 Sweep, Start-Stop (LIN, LOG)
 Sweep, Span
 Sweep, Marker
 Sweep outputs

2.3.46 Sweep, Start-Stop (LIN, LOG)

The generator features performance of a linear start-stop sweep (S-S LIN) for the parameters RF, AF and MEM.

A logarithmic start-stop sweep (S-S LOG) can be obtained for parameters RF, AF and LEV RF.

The start end-point can be higher than the stop end-point, causing the sweep and the voltage at the X output to progress from high to low.

In the case of the logarithmic sweep, the STEP size is equal to a constant fraction of the current setting. For RF or AF sweep the step size is entered in %, unit dB is used for level sweep.

Related instructions: Sweep, RF, AF, LEV RF, MEM
 Sweep parameter entry
 Sweep operating modes

2.3.47 Sweep, Span

The span sweep, which can be obtained for parameter RF/CF only, is characterized by the center frequency CF and a frequency span centered round this center frequency. The sweep starts from $CF - SPAN/2$ and runs linearly up to $CF + SPAN/2$.

It is possible during a span sweep run to modify the center frequency CF by entering a new value or by means of rotary knob variation. If parameter RF/CF is switched for variation, the display of the current sweep frequency is terminated and instead, the center frequency CF displayed. To have the current sweep frequency displayed again, key AUTO, SINGLE or MAN is pressed again.

The sweep parameters for span sweep and start-stop sweep are stored individually. This allows to stop a currently running start-stop sweep at a certain point in order to obtain a small range of this sweep with span sweep.

Example	Entry			IEC bus code	
	PARAMETER	DATA		ENTER/UNITS	
Entering center frequency 150 MHz	RF/CF <input type="text"/>	<input type="text" value="1"/>	<input type="text" value="5"/>	<input type="text" value="0"/> MHz	CF 150 MHZ
Entering span 400 kHz	SPAN <input type="text"/>	<input type="text" value="4"/>	<input type="text" value="0"/>	<input type="text" value="0"/> kHz	CF:SPAN 400 KHZ
Entering step size 1 kHz	STEP <input type="text"/>		<input type="text" value="1"/>	<input type="text"/> kHz	CF:STEP 1 KHZ
Entering step time 10 ms	TIME/ STEP <input type="text"/>	<input type="text" value="1"/>	<input type="text" value="0"/>	<input type="text"/> msec	TIME:CF 10 MS

Related instructions: Sweep, RF
Sweep parameter entry
Sweep operating modes

2.3.49 Sweep Outputs

The following outputs have been provided at the rear panel of the instrument for controlling and triggering oscilloscopes or XY recorders:

X-AXIS With activated sweep, this output provides a 0 to 10 V staircase for the X-deflection of an oscilloscope or an XY recorder. If the start end-point is higher than the stop end-point, the voltage at the X output progresses from high to low.

Z-AXIS The Z-AXIS output supplies a signal (0V/5V) for triggering and Z-blanking of an oscilloscope or for PEN LIFT control of an XY recorder. Changing the polarity is possible using the special function "Polarity Z-axis". If this special function is switched off, the voltage at the Z-AXIS output is LOW during the sweep and HIGH during back stroke or switched-off sweep.

Special function "Polarity Z-AXIS Inverted" Activating code: 33
Deactivating code: 34

MARKER A signal (0V/5V) is provided at the MARKER output as soon as the sweep has reached the marker frequency. This MARKER signal can be used for brightness control of an oscilloscope or for amplitude modulation (AM SQU) via the AM EXT input. Changing of polarity can be effected using special function "Polarity MARKER ". If this special function is switched off, the output signal is HIGH when the sweep reaches the marker value.

Special function "Polarity MARKER Inverted" Activating code: 35
Deactivating code: 36

Note: With a sweep of more than 1 000 000 steps, the accuracy of the X voltage and the marker is diminished the more the number of steps increases. Status message "12" is read out.

Related instructions: Sweep, RF, AF, LEV RF
Sweep parameter entry
Sweep, Marker
Special functions

2.3.50 Phase Offset

The phase of the RF output signal can be set as a function of a reference signal of identical frequency using the special function "Phase Offset".

Range: $\pm 180^\circ$

Resolution: 1°

Activating code: 23

Deactivating code: 24

Switching on "Phase Offset" changes the function of parameter key ΦM from phase modulation to phase offset. Key sequence ΦM — INT/ON then initiates the phase offset. Entry of value and variation are performed as is the case with the other parameters.

No phase offset is possible in simultaneous combination with FM or ΦM .

Display: Activation of phase offset is indicated by

φ DC
INT and " Δ ".

The phase is indicated in 3-digit form in the MODULATION display, which is used both for readout of the phase with phase offset and for readout of the modulation depth with AM. If AM and phase offset are simultaneously selected, the display shows the value of the parameter that was selected last.

Related instructions: Special functions

2.3.52 Store - Recall

50 complete instrument settings can be stored.

If an instrument setting with the sweep modes SINGLE or AUTO is called up, the recall automatically initiates the sweep run.

Storing the current instrument setting:

STO ____ Data ____ ENTER

Recalling a stored instrument setting:

RCL ____ Data ____ ENTER

Example	Entry			IEC bus code
	MEMORY	DATA	ENTER/UNITS	
Storing an instrument setting at memory location 7	STO <input type="text"/>	<input type="text" value="7"/>	ENTER <input type="text"/>	STO 7
Recalling an instrument setting from memory location 25	RCL <input type="text"/>	<input type="text" value="2"/> <input type="text" value="5"/>	ENTER <input type="text"/>	REC 25

Memory location 0 has been assigned a special function, for at this location the instrument setting valid prior to the last memory recall and PRESET is stored. This allows for any unintentionally deleted instrument settings to be retrieved by means of RCL 0.

Related instructions: Sweep, Memory

2.3.53 Special Functions

Special functions allow for further applications of Signal Generator SMHU other than the front-panel functions.

Switching on and off the special functions is effected via codes (data entry) (cf. Table 2-2).

Using code 0 and PRESET, all the storable special functions can be switched off in order for the generator to reassume the basic status.

Example	Entry			IEC bus code
	PARAMETER	DATA	ENTER/UNITS	
Switching on the special function "Transient-free Level Settings"	SHIFT <input type="checkbox"/> SPECIAL	1	ENTER <input type="checkbox"/>	ATT:FIXED
Switching off the special function "Transient-free Level Settings"	SHIFT <input type="checkbox"/> SPECIAL	2	ENTER <input type="checkbox"/>	ATT:NORMAL
Switching off all special functions	SHIFT <input type="checkbox"/> SPECIAL	0	ENTER <input type="checkbox"/>	SPEC 0

Display: Activation of special functions is indicated by special function LED SPEC (illuminated). The STATUS key is pressed to have the special function code displayed in the FREQUENCY display (see section on "STATUS").

Table 2-2 Special functions (part 1)

Special functions	Code	Remote control command
Transient-free level settings	1	ATT:FIXED
Level setting normal	2	ATT:NORMAL
Level emf	3	LEVEL:EMF
Level normal	4	LEVEL
AGC off	5	ALC:FIXED
AGC normal	6	ALC:NORMAL
Level control voltage by memory lookup	7	LEV:CONTROL:LOOKUP
Level control voltage calibrated	8	LEV:CONTROL:CAL
AM bandwidth narrow	9	SPECIAL 9
AM bandwidth normal	10	SPECIAL 10
FM bandwidth narrow	11	SPECIAL 11
FM bandwidth normal	12	SPECIAL 12
Reference frequency 5 MHz	13	REF:LOW
Reference frequency 10 MHz	14	REF:HIGH
Internal modulation via attenuator	15	MOD:REDUCED
Internal modulation normal	16	MOD:NORMAL
Internal two-tone modulation on	17	AM:DUAL:INT (e.g. AM)
Internal two-tone modulation off	18	AM:DUAL:AC (DC) (e.g. AM)

Table 2-2 Special functions (part 2)

Special functions	Code	Remote control command
125 MHz heterodyne band	21	HET_BAND:HIGH
15.625 MHz heterodyne band	22	HET_BAND:LOW
Phase offset on	23	PHASE:INT
Phase offset off	24	PHASE:OFF
Bandwidth of FRN synthesis wide	25	SPECIAL 25
Bandwidth of FRN synthesis normal	26	SPECIAL 26
Polarity FSK inverted	27	FM:FSK:INVERTED
Polarity FSK normal	28	FM:FSK:NORMAL
Polarity AM SQU inverted	29	AM:SQU:INVERTED
Polarity AM SQU normal	30	AM:SQU:NORMAL
Polarity PULSE inverted	31	PULSE:INVERTED
Polarity PULSE normal	32	PULSE:NORMAL
Polarity Z-AXIS inverted	33	SWP:Z_AXIS:INV
Polarity Z-AXIS normal	34	SWP:Z_AXIS:NORM
Polarity MARKER inverted	35	SWP:MARKER:INV
Polarity MARKER normal	36	SWP:MARKER:NORM
AF sawtooth signal inverted	37	AF:WAVE:SAW:DOWN
AF sawtooth signal normal	38	AF:WAVE:SAW:UP
Display off	39	DISPLAY: OFF
SRQ by trigger signal	41	SPECIAL 41
Deactivating special function 41	42	SPECIAL 42
External trigger on	43	SPECIAL 43
External trigger off	44	SPECIAL 44
Memory sweep fast mode	45	SWP:MODE:MEMORY:FAST
Memory sweep normal mode	46	SWP:MODE:MEMORY
Fast Hop Bus on	47	SWP:MODE:MEMORY:HOP
Fast Hop Bus off	48	SWP:MODE:MEMORY
Calibration routine for RF level	51	SPECIAL 51
Terminating calibration routine 51 (IEC bus only)	52	SPECIAL 52
Level correction off	55	LEVEL:CORRECTION:OFF
Level correction on	56	LEVEL:CORRECTION:ON
LCD background lighting off	60	SPECIAL 60
LCD background lighting on	61	SPECIAL 61
User Request	62	
Clear all memories	64	SPECIAL 64
Calibration routine for doubler	66	SPECIAL 66
Calibration routine for summing loop 1	67	SPECIAL 67
Calibration routine for "Level Control Voltage by Memory Lookup"	68	SPECIAL 68
Display of number of firmware version	71	
Display test	72	
RAM test	73	
EPROM test	74	
EEPROM test	75	
Electronic level setting 0 dB	76	
Electronic level setting -25 dB	77	
Display of FRN frequency	78	
Display of step frequency	79	
Display of frequency of summing loop 1	80	
Display of frequency of summing loop 2	81	
Display of sampler frequency	82	
Display of harmonic of RFO synchronization	83	
Display of RF divider factor	84	
Display of undivided synthesized frequency	85	

Special functions	Code	Remote control command
I/Q-impairment input	301	
Deactivating I/Q-impairment	302	IQ:IMPAIRMENT:OFF
Broadband AM on	303	AM:BROADBAND:ON
Broadband AM off	304	AM:BROADBAND:OFF
PRBS generator 9 bit	305	DM:PRBS:SHORT
PRBS generator off	306	DM:PRBS:OFF
PRBS generator 15 bit	307	DM:PRBS:LONG
PRBS generator off	308	DM:PRBS:OFF
Neg. clock edge active	309	DM:CLOCK:INVERTED
Pos. clock edge active	310	DM:CLOCK:NORMAL
GSM difference coding on	311	DM:CODER:ON
GSM difference coding off	312	DM:CODER:OFF
Digital modulation inverted	313	DM:INVERTED
Digital modulation normal	314	DM:NORMAL
Bandwidth 2.24 GHz-PLL wide	315	SPECIAL 315
Bandwidth 2.24 GHz-PLL normal	316	SPECIAL 316
Calibration routine for I/Q-modulator	320	CALIBRATION:IQ
Symbol timing	321	DM:CLOCK:SYMBOL
Bit timing	322	DM:CLOCK:BIT
JDC bit rate	323	DM:CLOCK:JDC
ADC bit rate	324	DM:CLOCK:ADC

Explanations of the individual special functions:

Transient-free level settings:	Transient-free level adjustment can be obtained within a range of 20 dB. Cf. section "Transient-free Level Settings".
Level emf:	Display of emf voltage. Cf. section "Level emf".
AGC off:	Automatic level control is switched to sample-and-hold mode for multi-transmitter measurements to obtain a higher intermodulation ratio. Cf. section "AGC off".
Level control voltage by memory lookup:	Alternative function for sample-and-hold operation with "AGC off" and PULSE modulation. Instead of a calibration being performed following each change in level or frequency, prestored correction values are looked up in a stored table, cf. section "AGC off" and "Modulation, PULSE".
Reference frequency 5 MHz:	The input or output reference frequency is changed from basic status 10 MHz to 5 MHz. Cf. section "Internal/External Reference Frequency".
Internal modulation via attenuator:	Internal modulation signal is attenuated by AF level setting. Cf. section "Two-tone Modulation".
Internal two-tone modulation on:	Two-tone modulation with internal modulation sources only.
125 MHz heterodyne band:	Heterodyne band 0.1 to 125 MHz (basic status 0.1 to 15.625 MHz) allows for higher FM deviation.
Phase offset on:	The phase of the RF signal can be modified based on a reference signal of identical frequency.
Bandwidth of FRN-synthesis broad:	The bandwidth of the FRN-phase locked loop can be switched to broad for testing purposes.
Polarity FSK inverted:	FSK signal with inverted polarity. Cf. section "Modulation, FSK".
Polarity AM SQU inverted:	AM SQU modulation with inverted polarity. Cf. section "Modulation, AM SQU".
Polarity PULSE inverted:	Pulse modulation with inverted polarity. Cf. section "Modulation, PULSE".
Polarität Z-AXIS inverted:	Z-AXIS signal with inverted polarity.
Polarity MARKER inverted:	MARKER signal with inverted polarity.
AF sawtooth signal inverted:	AF sawtooth signal with inverted polarity.
Display off:	The display is switched off. The instrument settings are no longer visible. PRESET switches the display on.
SRQ set off by trigger signal :	A service request SRQ is made possible by means of an external trigger.
External trigger:	Special function for keystroke simulation by means of an external trigger signal. Cf. section "External Trigger".

Memory sweep fast mode:	Memory sweep mode is switched over to fast mode. Cf. section "Sweep, Fast Mode Memory".
Fast Hop Bus on:	Fast hop bus mode is switched on. The addresses of the fast mode memories can be controlled as required via the fast hop bus connection (cf. section "Fast Hop Bus").
Calibration routine for RF level:	The input of the correction values for the calibrated RF level is made possible (cf. service manual).
Level correction on/off:	Level correction is switched on or off (on = basic state).
LCD background lighting on/off:	Switching on or off the LCD background lighting.
User Request:	Entering special function code 62 initiates a Service Request SRQ in LOCAL mode via the IEC bus. Cf. section "Service Request and Status Registers".
Clear all memories:	The memories for instrument settings (STORE-RECALL) and of Fast Mode are replaced by PRESET values. To protect against mal-operation the ENTER key must be pressed for at least 3 seconds after having entered the code.
Special functions 66 to 85:	Special functions required for service (cf. service manual).
I/Q-impairment input:	Allows the input of the parameters CARR LEAK, I>Q and QUAD OFFSET. Cf. section "I/Q-impairment".
Broadband AM on:	Broadband-AM with external modulation signal applied to the modulation input BB-AM located at the rear of the instrument. Cf. section "Modulation, Broadband-AM".
PRBS generator 9 bit: 15 bit	For internal GMSK modulation with pseudo random binary sequences. Cf. section "Modulation, GMSK".
Neg. clock edge active:	Input data for digital modulation are adopted in the case of the negative clock edge. Cf. section "Modulation, GMSK, GFSK, $\pi/4$ DQPSK".
Difference coding on:	Input data for digital modulation are coded according to the GSM-specification. Cf. section "Modulation, GMSK".
Digital modulation inverted:	Digital modulation with inverted polarity. Cf. section "Modulation, GMSK", GFSK, $\pi/4$ DQPSK.
Bandwidth 2.24 GHz-PLL wide:	The bandwidth of the 2.24 GHz-PLL can be switched to wide for special applications with external broadband-FM.
Calibration routine for I/Q-modulator:	Selectable self-calibration of the I/Q-modulator.
Symbol timing:	CLOCK input/output with $\pi/4$ DQPSK is switched to symbol timing instead of bit timing. Cf. section "Modulation $\pi/4$ DQPSK".
JDC bit rate:	ADC coder is switched to JDC bit rate. Cf. section "Modulation, $\pi/4$ DQPSK".

2.3.54 Self-test

The SMHU Signal Generator performs a self-test at turn-on and permanently during operation.

When the instrument is switched on, the ROM contents and, with each memory call, also the RAM contents are checked. On detection of an error, a respective error message is read out.

The most important instrument functions are automatically monitored during operation.

A faulty function detected during the self-test is indicated by the status LED (flashing) and by a Service Request message. The status code identifying the error can be read out in the MODULATION display by pressing the STATUS key (cf. Table 2-5, status codes of errors and overrange/ underrange settings in section "Status").

In addition, internal test points can be scanned via the keyboard or the IEC bus and the results read out in the LEVEL display. These more detailed test facilities are described in the Service Manual.

2.3.55 Status

The Generator produces numeric status messages to identify special functions, errors and the options fitted.

The status codes of special functions are read out in the FREQUENCY display. In the MODULATION display, the status codes of errors and overrange/underrange settings are specified. The installed coder option is indicated in the LEVEL display.

They can also be scanned via the IEC bus (see section "Error Handling"). The meanings of the status codes are described in Table 2-4 and Table 2-5.

Operation: The status codes are shown in the FREQUENCY, MODULATION and LEVEL displays as long as the STATUS key is pressed. In the case of several status messages, the codes are automatically read out in repeated sequence at continuous hold-down of the STATUS key, or are indicated one following the other each time the STATUS key is pressed. Any option with which the instrument is fitted is additionally indicated in the LEVEL display when the STATUS key is pressed.

Display: The special functions LED SPEC is continuously illuminated if special functions are currently selected.

The status LED is continuously illuminated if overrange/underrange settings were made.

The status LED flashes continuously in the case of function errors.

The status LED flashes briefly in the case of input errors.

The status codes of the special functions are specified in the FREQUENCY display as follows:



Code 0 is indicated if no special function is currently switched on.

The status codes of the function errors and the overrange/underrange settings are indicated in the MODULATION display as follows:

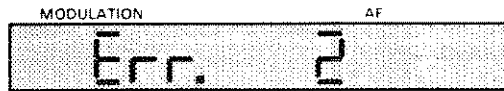

Code 0 is specified in case of no error.

The status codes of the input errors are in case of faulty entries automatically indicated in the MODULATION display for a short period of time in the following form:

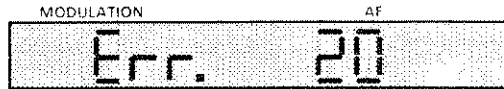

The status codes of the option display are read out in the LEVEL display as follows:

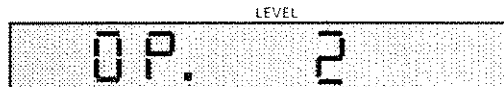

IEC bus: A Service Request message (SRQ) is given out in the case of input errors, overrange/underrange settings as well as function errors. The type of error can be ascertained from the Event Status Register. The status code can be read out to enable exact error identification (see section "Error Handling").

Table 2-4 Status codes of the special functions

Code	Meaning
0	No special function currently activated
1	Transient-free level settings
3	Level emf
5	AGC off
7	Level control voltage by mem. lookup
13	Reference frequency 5 MHz
15	Internal modulation via attenuator
17	Internal two-tone modulation on
21	125 MHz heterodyne band
23	Phase offset on
25	Bandwidth of FRN synthesis wide
27	Polarity FSK inverted
29	Polarity AM SQU inverted
31	Polarity PULSE inverted
33	Polarity Z-AXIS inverted
35	Polarity MARKER inverted

Code	Meaning
37	AF sawtooth signal inverted
41	SRQ by trigger signal
43	External trigger
45	Memory sweep fast mode
47	Fast hop bus
55	Level function off
301	I/Q-impairment input
303	Broadband-AM on
305	PRBS-generator 9 bit
307	PRBS-generator 15 bit
309	Neg. clock edge active
311	GSM difference coding on
313	Digital modulation inverted
315	Bandwidth 2.24 GHz-PLL wide
321	Symbol timing
323	JDC bit rate

Table 2-5 Status codes of errors and overrange/underrange settings

Code	Meaning
0	No error
	Overrange/underrange settings
1	Level > 13 dBm
2	AM, $\pi/4$ DQPSK not specified for current level
3	AM not specified for AF > 50 kHz
4	PHM not specified for AF > 10 kHz
5	RF underrange/overrange
7	AM EXT signal out of tolerance
8	FM/PHM EXT signal out of tolerance
9	FM/PHM deviation too large with current RF
10	RF < 1 MHz or > 2000 MHz with BB-AM, BB-FM, I/Q or DM
11	Level sweep > 20 dB
12	Sweep with more than 1000000 steps: decreasing accuracy of X voltage and marker
13	AF > 2 kHz with square or sawtooth waveforms
	Input errors
20	Syntax error
21	Entered value outside permissible range
22	Illegal setting combination
23	Illegal header (IEC bus)
24	Illegal unit for currently selected parameter
25	No variation possible
26	Illegal input due to lacking optional equipment
29	Invalid code for special functions
30	Violation of permissible range with SPAN sweep

Code	Meaning
	Function errors
40	40 MHz reference oscillator out of synchronization
41	130 MHz reference oscillator out of synchronization
42	FRN loop out of synchronization
43	STEP loop out of synchronization
44	SUM1 loop out of synchronization
45	FM loop out of synchronization
46	SUM2 loop out of synchronization
47	RF loop out of synchronization
48	AGC off
49	Coder clock frequency out of tolerance
50	2.24 GHz loop out of synchronization
61	EPROM data error
62	RAM error
63	Error in stored instrument settings
64	Error in fast mode memories
65	Error in level correction values (EEPROM)
66	Error in local leveling values (EEPROM)
67	Error in SUM1 calibration values (EEPROM)
68	Error in ALC calibration values (EEPROM)
69	Error in the I/Q-modulator calibration values (RAM)
70	External overvoltage at RF output
71	No calibration possible
72	Error in diagnostic A/D converter
73	Error in fast hop bus interface
74	Illegal fast hop bus address

Table 2-6 Status codes of option display

Code	Meaning
-	no option fitted
2	GMSK coder option
3	DECT coder option
4	ADC coder option

2.3.56 Preset

Key sequence SHIFT _____ PRESET sets the instrument to a defined basic status.

Table 2-7 Default status

Parameter	Setting	Parameter	Preset to
Reference frequency	10 MHz internal	Variation step size	FINE
RF	100 MHz	RF step	1 MHz
LEV RF	-30 dBm	LEV RF step	0.1 dB
Set parameter	RF	AF step	100 Hz
Offset	Switched off	LEV AF step	10 mV
Modulation	Switched off	Modulation source	internal
Pre-emphasis	Switched off	AM modulation depth	30 %
AF	1 kHz	AM step	1 %
LEV AF	1 V	FM deviation	10 kHz
AF signal	Sine	BB-FM deviation	1 MHz
AF fixed frequency (FIXED)	0 Hz	FM step	1 kHz
Sweep	Switched off	Pre-emphasis	50 μ s
Variation, Δ REF function	Switched off	PHM deviation	1 rad
Variation, HOLD function	Switched off	PHM step	0.01 rad
Special functions	Switched off	CARR LEAK	0 %
Status and mask registers of		I > Q	0 %
Service Request function	Unchanged	QUAD OFFSET	0 deg
IEC bus address	Unchanged	GMSK filter no.	3
		DECT filter no.	5
		ADC filter no.	3
		Offset	0
		Sweep mode	RF, Start-Stop LIN
		RF sweep, start	1 MHz
		RF sweep, stop	2160 MHz
		RF sweep, span	1 MHz
		RF sweep, step (lin)	1 MHz (Start-Stop), 10 kHz (span)
		RF sweep, step (log)	1 %
		RF sweep, time/step	10 ms
		RF sweep, marker	1000 MHz (Start-Stop), 100 MHz (span)
		AF sweep, start	1 kHz
		AF sweep, stop	100 kHz
		AF sweep, step (lin)	1 kHz
		AF sweep, step (log)	1 %
		AF sweep, time/step	10 ms
		AF sweep, marker	10 kHz
		LEV RF sweep, start	-10 dBm
		LEV RF sweep, stop	+ 10 dBm
		LEV RF sweep, step	0.1 dB
		LEV RF sweep, time/step	10 ms
		LEV RF sweep, marker	0 dBm
		Marker	Switched on
		MEM sweep	Unchanged
		Memory locations	Unchanged

2.3.57 IEC Bus Address

The IEC bus address can be displayed and set using the keyboard and remains stored until overwritten by a new address. The address range is from 0 to 30. The Signal Generator is factory-set to address 28.

Example	Entry			
	REM	DATA	ENTER/UNITS	
IEC bus address read out in display	SHIFT <input type="checkbox"/> <input type="checkbox"/> IEC ADDR			
Setting IEC bus address 8	SHIFT <input type="checkbox"/> <input type="checkbox"/> IEC ADDR	<input type="text" value="8"/>	ENTER <input type="text"/>	

Display: The IEC bus address is displayed in the FREQUENCY display as long as key IEC ADDR is pressed following previous actuation of the SHIFT key.

2.4 Remote Control of the SMHU Signal Generator via IEC Bus

As standard, the SMHU Signal Generator is fitted with an IEC bus interface, that corresponds to the IEC 625-1 or IEEE 488 standard.

The recommended American IEEE 488.2 standard (IEEE standard codes, formats, protocols and common commands) has additionally been considered, which describes data transfer formats and common commands.

2.4.1 Brief Instructions for Simple Applications

- 1) Connect controller and SMHU using the IEC bus cable.
- 2) Set device address 28 on SMHU:

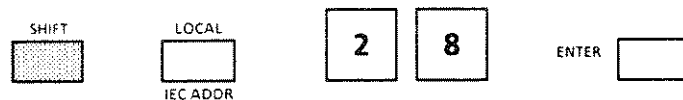

- 3) Device settings

The first command sent via the IEC bus interface sets the SMHU to the remote status indicated by REM LED (illuminated).

BASIC command (Controller Rohde & Schwarz PCA5)	Effect on SMHU
IECOUT 28, "*RST"	Instrument in basic status
IECOUT 28, "RF 155.623458MHZ"	Frequency (RF) is set
IECOUT 28, "LEVEL -11.5DBM"	Level (into 50 Ω) is set
IECOUT 28, "AF 12.5KHZ; FM:INT 40KHZ"	Modulation frequency (AF) and internal frequency modulation are set

- 4) Following actuation of the LOCAL key, the generator abandons the remote status and is ready for manual operation again.

2.4.2 Setting the Device Address

In the LOCAL mode (REM LED off), the IEC bus address can be displayed and set using key sequence SHIFT + IEC ADDR (cf. also the page preceding). It remains stored also at power-off of the instrument. The address range covers 0 to 30, the instrument is factory-set to 28.

The address is the decimal equivalent of bits 1 to 5 of the talker or listener address. This form is also used for the IEC bus commands of the controllers.

2.4.3 Device Messages

Device messages are transmitted on the data lines of the IEC bus, with the attention line being High (not active). The ASCII code (ISO 7-bit code) is used (cf. Table 2-14).

- * The messages from the controller to the SMHU (programming messages) are in the following referred to as commands.

They include the following four groups:

- Device-specific setting commands
- Device-specific data request commands
- Common, device-independent setting commands (Common commands in accordance with IEEE 488.2)
- Common, device-independent data request commands (Common queries in accordance with IEEE 488.2)

The tables listed in the following specify all these commands. Their respective syntax is described in section 2.4.3.6.

The SMHU command set is largely characterized by upward compatibility with that of the Rohde & Schwarz Signal Generators SMG, SMH and SMX. The commands of SMGU and SMHU are identical.

- * The messages from the SMHU to the controller (response messages) are specified in combination with their associated data request commands. As to their syntax, refer to section 2.4.3.7.

2.4.3.1 Device-specific Setting Commands

All the instrument functions to be set via the SMHU keyboard can - with the exception of the rotary knob variation - also be obtained via the IEC bus. The instrument performance initiated via setting commands fully corresponds to that obtained by keyboard entries.

The shortest-possible notation is shown in bold print.

For better illustration of the hierarchical command structure, the beginning of the commands within one block is indicated once only.

← indicates the default unit

⇐ indicates the basic status (following *RST)

[:RF] The text in square brackets is optional only and may also be omitted without changing the effect of the command.

Table 2-8

Header	Number	Units	Meaning
AF[:SYNTHESIZER]	Value	HZ ← KHZ MHZ	Setting AF synthesizer frequency
AF:START :STOP :STEP :MARKER	Value	HZ ← KHZ MHZ	AF sweep parameters Step width for linear sweep
:LOG_STEP	Value	PCT ←	Step width for logarithmic sweep
AF:VAR_STEP	Value	HZ ← KHZ MHZ	AF variation step size
AF:WAVEFORM:SINE ⇐ :SQUARE :SAWTOOTH:UP :DOWN			Setting signal form of AF synthesizer (:DOWN is special function)
AF:FIXED	Value	HZ ← KHZ MHZ	Set frequency of AF fixed frequency generator
AF:OUTPUT:SYNTHESIZER ⇐ :FIXED			Switching signal of AF synthesizer or AF fixed frequency generator to AF output
ALC:FIXED :NORMAL ⇐			Special function: " AGC off" " AGC normal"

Header	Number	Units	Meaning
AM	Value	PCT ←	Setting modulation depth ¹⁾
AM:INTERNAL[:SYNTHESIZER] :FIXED :EXTERNAL[:AC] :DC :DUAL[:AC] :DC :INTERNAL :SQUARE[:NORMAL] :INVERTED	Value	PCT ←	Switching on AM with selected modulation source and setting modulation depth DUAL: Two-tone modulation DUAL:INTERNAL is special function AM:SQUARE:INVERTED is special function
AM:INTERNAL[:SYNTHESIZER] :FIXED :EXTERNAL[:AC] :DC :DUAL[:AC] :DC :INTERNAL :SQUARE[:NORMAL] :INVERTED			Switching on AM with selected modulation source and setting stored value of modulation depth DUAL: Two-tone modulation DUAL:INTERNAL is special function AM:SQUARE:INVERTED is special function
AM:OFF ←			Switching off AM
AM:VAR_STEP	Value	PCT ←	AM variation step size
AM:BROADBAND:ON :OFF ←			
ATTENUATOR:FIXED :NORMAL ←			Special function: "Transient-free Level Settings" "Level Setting Normal"
CALIBRATION:IQ			
CF CF:SPAN :STEP :MARKER	Value	HZ ← KHZ MHZ GHZ	RF span sweep parameters Center frequency CF
DECREMENT:AF :AM :FM :LEVEL:AF :LEVEL:RF :PHASE :PHM :RF :SWP			Downward variation by one step FM also applies to broadband-FM One step with manual sweep
DIRECT	Hexadec. value		Direct setting of complete instrument
DISPLAY:OFF			Special function: "Display off"

1) If the respective modulation is currently not yet activated, the modulation with the modulation source selected last is switched on.

Header	Number	Units	Meaning
DM :ON :OFF ⇐			Switching on/off digital modulation (DM) 2) 3)
DM :INVERTED :NORMAL ⇐			Special function: 2) 3) Digital modulation inverted Digital modulation normal
DM:CLOCK :INVERTED :NORMAL ⇐			Special function: 2) 3) DM clock edge inverted DM clock edge normal
DM:CLOCK :SYMBOL :BIT ⇐			Special function: 3) Symbol timing on Symbol timing off
DM:CLOCK :JDC :ADC ⇐			Special function: 3) JDC bit rate on JDC bit rate off
DM:CODER :ON :OFF ⇐			Special function: 2) Difference coding on Difference coding off
DM:FILTER	Value		Setting DM filter number 2) 3)
DM:PRBS :SHORT :LONG :OFF ⇐			Special function: 2) 3) PRBS generator, 9 bit PRBS generator, 15 bit PRBS generator off
FM	Value	HZ ← KHZ MHZ	Setting FM deviation 1)
FM:INTERNAL[:SYNTHESIZER] :FIXED :EXTERNAL[:AC] :DC :DUAL[:AC] :DC :INTERNAL :FSK[:NORMAL] :INVERTED	Value	HZ ← KHZ MHZ	Switching on FM with selected modulation source and setting deviation DUAL: Two-tone modulation DUAL:INTERNAL is special function FSK:INVERTED is special function
FM:INTERNAL[:SYNTHESIZER] :FIXED :EXTERNAL[:AC] :DC :DUAL[:AC] :DC :INTERNAL :FSK[:NORMAL] :INVERTED			Switching on FM with selected modulation source and setting stored deviation value DUAL: Two-tone modulation DUAL:INTERNAL is special function FSK:INVERTED is special function

- 1) If the respective modulation is currently not yet activated, the modulation with the modulation source selected last is switched on.
- 2) With option SMHU-B2 or SMHU-B3.
- 3) With option SMHU-B4.

Header	Number	Units	Meaning
FM:OFF ←			Switching off FM
FM:VAR_STEP	Value	HZ ← KHZ MHZ	FM variation step size (and broadband-FM variation step size ²⁾)
FM:BROADBAND	Value	HZ ← KHZ MHZ	Setting broadband-FM deviation ¹⁾ ²⁾
FM:BROADBAND :INTERNAL[:SYNTHESIZER] :FIXED :EXTERNAL[:AC]	Value	HZ ← KHZ MHZ	Switching on broadband-FM with selected modulation source and setting deviation ²⁾
FM:BROADBAND :INTERNAL[:SYNTHESIZER] :FIXED :EXTERNAL[:AC]			Switching on broadband-FM with selected modulation source and setting stored deviation value ²⁾
FM:BROADBAND:OFF ←			Switching off broadband-FM ²⁾
FM:PREEMPHASIS	Value	S ← MS US	Switching on FM pre-emphasis and setting specified value.
FM:PREEMPHASIS:ON :OFF ↑			Switching on FM pre-emphasis to stored value. Switching off pre-emphasis.
HEADER:ON ↑ :OFF			Messages from SMHU to controller sent with or without header.
HET_BAND:LOW ↑ :HIGH			Special function: "15.625 MHz heterodyne band" "125 MHz heterodyne band"
INCREMENT:AF :AM :FM :LEVEL:AF :LEVEL:RF :PHASE :PHM :RF :SWP			Upward variation by one step FM also applies to broadband-FM One step with manual sweep
IQ:ON ← :OFF			Switching on/off I/Q modulation ²⁾
IQ:CARRIER_LEAKAGE	value	PCT ←	Setting carrier leakage with I/Q modulation, Switching on special function "I/Q-impairment input" ²⁾

1) If the respective modulation is currently not yet activated, the modulation with the modulation source selected last is switched on.

2) Only with SMHU models featuring broadband modulators (SMHU .58).

Header	Number	Units	Meaning
IQ:IMBALANCE		PCT ←	Setting I/Q-imbalance. Switching on special function "I/Q-impairment input" ¹⁾
IQ:QUADRATURE_OFFSET	value	DEG ←	Setting quadrature offset with I/Q modulation, Switching on special function "I/Q-impairment input" ¹⁾
IQ:IMPAIRMENT:OFF ←			Switching off special function "I/Q-impairment input" and setting impairment parameters to zero ¹⁾
LEVEL:AF	Value	V ← MV UV	Setting AF level
LEVEL:AF:VAR_STEP	Value	V ← MV UV	Variation step size of AF level
LEVEL:AF:ON ← :OFF			Switching on AF output signal to stored value Switching off AF output signal
LEVEL[:RF]	Value	DBM ← DBUV V MV UV	Setting RF level (into 50 Ω)
LEVEL[:RF]:EMF	Value	DBUV ← V MV UV	RF level, emf entry (Special function: "Level emf")
LEVEL[:RF]:CONTROL:LOOKUP :CALIBRATION ←			Special function: "Level Control Voltage by Memory Lookup" "Level Control Voltage Calibrated"
LEVEL[:RF]:START :STOP :MARKER	Value	DBM ← DBUV V MV UV	RF level sweep parameters
LEVEL[:RF]:STEP	Value	DB ←	Sweep step width of RF level
LEVEL[:RF]:VAR_STEP	Value	DB	Variation step size of RF level
LEVEL[:RF]:ON ← :OFF			Switching on RF output signal to stored level Switching off RF output signal
LEVEL[:RF]:OFFSET	Value	DB ←	RF level offset

1) Only with SMHU models featuring broadband modulator

Header	Number	Units	Meaning
LEVEL[:RF]:OFFSET:ON :OFF ←			Switching on RF level offset to stored value Switching off RF level offset
LEVEL[:RF]:CORRECT_INDEX	Value		Level correction: Select correction value index, associated frequency is set (see Service Manual)
LEVEL[:RF]:CORRECTION	Value	DB ←	Entering correction value and storing it (see Service Manual)
LEVEL[:RF]:CORRECTION:ON :OFF ←			Special function: "Level Correction on/off"
MEMORY:START :STOP	Value		Memory sweep parameters
MEMORY:FAST:START :STOP	Value		Fast memory sweep parameters
MODULATION:REDUCED :NORMAL ←			Special function: "Internal Modulation via Attenuator" "Internal Modulation Normal"
PHASE PHASE:INTERNAL	Value	DEG ←	Setting internal phase offset
PHASE:INTERNAL			Switching on internal phase offset (value 0)
PHASE:OFF ←			Switching off phase offset
PHASE:VAR_STEP	Value	DEG ←	Variation step size of phase offset
PHM	Value	RAD ←	Setting phase modulation deviation ¹⁾
PHM:INTERNAL[:SYNTHESIZER] :FIXED :EXTERNAL[:AC] :DUAL[:AC] :INTERNAL	Value	RAD ←	Switching on phase modulation with selected modulation source and set deviation DUAL: Two-tone modulation DUAL:INTERNAL is special function
PHM:INTERNAL[:SYNTHESIZER] :FIXED :EXTERNAL[:AC] :DUAL[:AC] :INTERNAL			Switching on phase modulation with selected modulation source and setting stored value for deviation DUAL: Two-tone modulation DUAL:INTERNAL is special function
PHM:OFF ←			Switching off phase modulation
PHM:VAR_STEP	Value	RAD ←	PHM variation step size
PRESET			Setting device to basic status

- 1) If the respective modulation is currently not yet activated, the modulation with the modulation source selected last is switched on.

Header	Number	Units	Meaning
PULSE:ON :OFF ←			Switching pulse modulation on/off
PULSE:INVERTED :NORMAL ←			Special function: "Polarity PULSE Inverted" "Polarity PULSE Normal"
RECALL	Value		Recalling stored instrument setting (same effect as *RCL)
REFERENCE_OSCILLATOR:INTERNAL :EXTERNAL ←			Internal reference frequency External reference frequency
REFERENCE_OSCILLATOR:LOW :HIGH ←			Reference frequency 5 MHz (Special function) Reference frequency 10 MHz
RF	Value	HZ ← KHZ MHZ GHZ	RF setting
RF:START :STOP :STEP :MARKER	Value	HZ ← KHZ MHZ GHZ	RF start/stop sweep parameters RF: step width for linear sweep
:LOG_STEP	Value	PCT ←	RF: step width for logarithmic sweep
RF:VAR_STEP	Value	HZ ← KHZ MHZ GHZ	RF variation step size
RF:OFFSET	Value	HZ ← KHZ MHZ GHZ	Frequency offset
RF:OFFSET:ON :OFF ←			Switching on frequency offset to stored value Switching off frequency offset (value remains stored)
SPECIAL_FUNCTION	Value 1)		Activating and deactivating special function using respective code (see Table 2-2 in section 2.3.53) (Alternatively to the special commands for each special function)
STORE	Value		Storing instrument setting (same effect as *SAV)
STORE:FAST	Value		Storing instrument setting in fast memory

1) Several numeric entries are possible in this case, separated by comma (,).

Header	Number	Units	Meaning
SWP::MODE:RF[:LIN] ← :LOG :CF[:LIN] :AF[:LIN] :LOG :LEVEL[:RF] :MEMORY :MEMORY:FAST :HOP_BUS			Definition of sweep mode RF start/stop sweep RF span sweep (center frequency) AF sweep Level sweep Memory sweep Fast memory sweep Fast hop bus mode (SMHU .56/.58 only)
SWP:AUTO :SINGLE :MANUAL :BREAK :RESET :OFF ↑			Switching sweep on/off (BREAK: same effect as SWP:MANUAL)
SWP:MARKER:ON ↑ :OFF			Switching sweep marker on/off
SWP:MARKER:INVERTED :NORMAL ↑			Special function: "Polarity MARKER Inverted" "Polarity MARKER Normal"
SWP:Z_AXIS:INVERTED :NORMAL ↑			Special function: "Polarity Z-AXIS Inverted" "Polarity Z-AXIS Normal"
TALK_TERMINATOR:NL_END ↑ :CR_NL_END			Definition of end character in talker mode: New Line + End Carriage Return + New Line + End
TEST:POINT	Value		Selection of an internal test point (Special function: "Diagnostic Test Point")
TEST:OFF ←			Switching off special function "Diagnostic Test Point"
TIME:RF_SWP :CF_SWP :AF_SWP :LEVEL_SWP[:RF] :MEMORY_SWP :MEMORY_SWP:FAST	Value	S ← MS US	Step time for respective sweep mode

2.4.3.2 Device-specific Data Request Commands and Messages Sent by the SMHU

The shortest-possible notation for the data request commands is shown in bold print.

[:RF] The text in square brackets is optional and may also be omitted without changing the effect of the command.

Table 2-9

Data request command	Message sent by the SMHU to the controller					Unit 1)	Meaning
	Header	Number					
		Max. no. of charact.	For- mat	Pol. sign	Example		
AF[:SYNTHESIZER]?	AF:SYN	6	NR1		12500	Hz	Frequency of AF synthesizer with active AF sweep, current frequency
AF:START?	AF:START	6	NR1		500	Hz	AF sweep parameters
AF:STOP?	AF:STOP	6	NR1		12500	Hz	
AF:STEP?	AF:STEP	6	NR1		10	Hz	
AF:LOG_STEP?	AF:LOG-ST	6	NR2		10.00	%	
AF:MARKER?	AF:MARK	6	NR1		10000	Hz	
AF:VAR_STEP?	AF:VAR	6	NR1		25	Hz	AF variation step size
AF:OUTPUT?	AF:OUTPUT:SYN AF:OUTPUT:FIX	0 0					Signal at AF output
AF:WAVEFORM?	AF:WAVE:SINE AF:WAVE:SQUA AF:WAVE:SA:U AF:WAVE:SA:D	0 0 0 0					Signal form of AF synthesizer Sawtooth rising Sawtooth falling (Special function)
AF:FIXED?	AF:FIX	4	NR1		1000	Hz	Frequency of AF fixed frequency generator
AM?	AM:INT:SY AM:INT:FI AM:EXT:AC AM:EXT:DC AM:DUA:AC AM:DUA:DC AM:DUA:IN AM:SQU:NO AM:SQ:IN AM:OFF	5 5 5 5 5 5 5 5 5 0	NR2 NR2 NR2 NR2 NR2 NR2 NR2 NR2 NR2		32.1 32.1 32.1 32.1 32.1 32.1 32.1 100.0 100.0	% % % % % % % % %	AM modulation source(s) and modulation depth Two-tone mod. Int. two-tone mod. AM-SQU., polarity norm. AM-SQU., polarity invert.
AM:VAR_STEP?	AM:VAR	5	NR2		2.5	%	Variation step size of AM modulation depth
ATTEN:CONT?	ATT:CONT ATT:NORM	4 0	NR2		18.9	dB	Electronic attenuation with transient-free level setting. Transient-free level setting off.

Data request command	Message sent by the SMHU to the controller					Unit 1)	Meaning
	Header	Number					
		Max. no. of charact.	For- mat	Pol. sign	Example		
CF?	CF	13	NR2	-	111222333.4	Hz	Center frequency with active RF span sweep, otherwise frequency (RF)
	RF	13	NR2	-	111222333.4	Hz	
CF:SPAN?	CF:SPAN	12	NR2		1000000.0	Hz	RF span sweep parameters
CF:STEP?	CF:STEP	12	NR2		2000.0	Hz	
CF:MARKER?	CF:MARK	13	NR2	-	111222000.0	Hz	
DIRECT?	DIRECT	138	HEX				Read complete instrument setting (see service manual)
DM?	DM:ON	0					Digital modulation 1)
	DM:OFF	0					
DM:FILTER?	DM:FILTER	2	NR1		3		DM filter number 1)
ERRORS?	ERRORS	2	NR1 2)		1, 5, 40		Error codes (see Table 2-5) 0 means no error.
FM?	FM:INT:SYS	7	NR1		75000	Hz	FM modulation source(s) and FM deviation
	FM:INT:FI	7	NR1		75000	Hz	
	FM:EXT:AC	7	NR1		75000	Hz	
	FM:EXT:DC	7	NR1		75000	Hz	Two-tone mod.
	FM:DUA:AC	7	NR1		75000	Hz	
	FM:DUA:DC	7	NR1		75000	Hz	
	FM:DUA:IN	7	NR1		75000	Hz	Int. two-tone mod. FSK polarity normal FSK polarity inverted
	FM:FSK:NO	7	NR1		75000	Hz	
	FM:FSK:IN	7	NR1		75000	Hz	
FM:OFF	0						
FM:VAR_STEP?	FM:VAR	7	NR1		2000	Hz	Variation step size of the FM deviation
FM:BROADBAND?	FM:BROAD:INT:SY	8	NR1		2500000	Hz	Broadband-FM modulation source and -deviation 2)
	FM:BROAD:INT:FI	8	NR1		2500000	Hz	
	FM:BROAD:EXT:AC	8	NR1		2500000	Hz	
	FM:BROAD:OFF	0					
FM:PREEMPHASIS?	FM:PREEMPH	7	NR3		75.0E-6	s	FM pre-emphasis
	FM:PREEMPH:OFF	0					
IQ?	IQ:ON	0					I/Q modulation 2)
	IQ:OFF	0					
IQ:CARRIER_LEAKAGE? IQ:IMBALANCE? IQ: QUADRATURE_OFFSET?	IQ:CARR	2	NR1		25	%	Carrier leakage I/Q-imbalance Quadrature offset 2)
	IQ:IMBAL	5	NR2	+	+9.9	%	
	IQ:QUADR	4	NR2	+	-9.9	DEG	

*) The unit is not sent.

1) Only with SMHU models featuring options SMHU-B2, SMHU-B3 or SMHU-B4

2) Only with SMHU models featuring broadband modulator (SMHU .58)

Data request command	Message sent by the SMHU to the controller					Unit 1)	Meaning
	Header	Number					
		Max. no. of charact.	For- mat	Pol. sign	Example		
LEVEL:AF?	LEVEL:AF LEVEL:AF:OFF	6 0	NR2		0.1256	V	AF level
LEVEL:AF:VAR_STEP?	LEVEL:AF:VAR	6	NR2		0.0250	V	Variation step size of the AF level
LEVEL[:RF]?	LEVEL:RF LEVEL:RF:OFF	6 0	NR2	+	-112.8	dBm	RF level (into 50 Ω) with active level sweep; current level
LEVEL[:RF]:EMF?	LEVEL:RF:EMF LEVEL:RF:OFF	6 0	NR2	+	+120.5	dBμV	RF level: emf
LEVEL[:RF]:START? LEVEL[:RF]:STOP? LEVEL[:RF]:STEP? LEVEL[:RF]:MARKER?	LEVEL:RF:START LEVEL:RF:STOP LEVEL:RF:STEP LEVEL:RF:MARK	6 6 5 6	NR2 NR2 NR2 NR2	++ +	-112.0 -92.8 0.2 -102.8	dBm dBm dB dBm	RF level sweep parameters
LEVEL[:RF]:VAR_STEP?	LEVEL:RF:VAR	4	NR2		2.5	dB	Variation step size of the RF level
LEVEL[:RF]:OFFSET?	LEVEL:RF:OFFSET LEVEL:RF:OFFSET: OFF	5 0	NR2	+	-20.0	dB	RF level offset
LEVEL[:RF]:CORRECTION?	LEVEL:RF: CORRECTION	5	NR2		1.26	dB	RF level correction value
LEVEL[:RF]:CORRECT_INDEX?	LEVEL:RF: CORRECT-INDEX	2	NR1		38		Index of RF level correction value
MEMORY?	MEMORY	2	NR1		12		Current memory number with memory sweep
MEMORY:START? MEMORY:STOP?	MEMORY:START MEMORY:STOP	2 2	NR1 NR1		1 25		Memory sweep parameters
MEMORY:FAST:START? MEMORY:FAST:STOP?	MEMORY:FAST:START MEMORY:FAST:STOP	4 4	NR1 NR1		10 150		Fast memory sweep parameters
PHASE?	PHASE:INT PHASE:OFF	4 0	NR1	+	+120	DEG	State and value of phase offset
PHASE:VAR_STEP?	PHASE:VAR	3	NR1		10	DEG	Variation step size of phase offset
PHM?	PHM:INT:SY PHM:INT:FI PHM:EXT:AC PHM:DUA:AC PHM:DUA:IN PHM:OFF	7 7 7 7 7 0	NR2 NR2 NR2 NR2 NR2		12.50 12.50 12.50 12.50 12.50	RAD RAD RAD RAD RAD	Modulation source(s) and deviation of phase modulation. Two-tone mod. Int. two-tone mod.

*) The unit is not sent.

Data request command	Message sent by the SMHU to the controller					Unit 1)	Meaning
	Header	Number					
		Max. no. of charact.	For- mat	Pol. sign	Example		
PHM:VAR_STEP?	PHM:VAR	7	NR2		0.25	RAD	Variation step size of deviation of phase modulation
PULSE?	PULSE:ON	0					Pulse modulation status
	PULSE:OFF	0					
REFERENCE_ OSCILLATOR?	REF:INT	0					Reference frequency source
	REF:EXT	0					
RF?	RF	13	NR2	-	111222333.4	Hz	RF with active RF sweep: current frequency
RF:START?	RF:START	13	NR2	-	111222333.4	Hz	RF start/stop sweep parameters
RF:STOP?	RF:STOP	13	NR2	-	555666777.8	Hz	
RF:STEP?	RF:STEP	12	NR2		2500.0	Hz	
RF:LOG_STEP?	RF:LOG-ST	5	NR2		0.01	%	
RF:MARKER?	RF:MARK	13	NR2	-	222000000.0	Hz	
RF:VAR_STEP?	RF:VAR	12	NR2		2500.0	Hz	RF variation step size
RF:OFFSet?	RF:OFFSET	13	NR2	+	-10700000.0	Hz	RF offset
	RF:OFFSET:OFF	0					
SPECIAL_FUNCTION?	SPECIAL	3	NR1 2)		1, 21, 103		Codes of activated special functions (see Table 2-2) 0 means no special function is activated.
SWP:MODe?	SWP:MODE:RF:LIN	0					Sweep mode (Fast memory sweep) (Fast hop bus mode, SMHU .56/.58 only)
	SWP:MODE:RF:LOG	0					
	SWP:MODE:CF:LIN	0					
	SWP:MODE:AF:LIN	0					
	SWP:MODE:AF:LOG	0					
	SWP:MODE:LEV:RF	0					
	SWP:MODE:MEMORY	0					
	SWP:MODE:MEM:FA	0					
	SWP:MODE:MEM:HO	0					
SWP?	SWP:AUT	0					Sweep status
	SWP:SIN	0					
	SWP:MAN	0					
	SWP:OFF	0					
SWP:MARKER?	SWP:MARKER:ON	0					Status of sweep marker
	SWP:MARKER:OFF	0					

*) The unit is not sent.

Data request command	Message sent by the SMHU to the controller					Unit *)	Meaning
	Header	Number					
		Max. no. of charact.	Format	Pol. sign	Example		
TEST:POINT?	TEST:POINT	2	NR1		17		Selected diagnostic test point
	TEST:OFF	0					Diagnostic test off
TEST:VOLTAGE?	TEST:VOLT	8	NR2	+	+0 1255	V	Voltage at selected test point
	TEST:OFF	0					Diagnostic test off
TIME:RF_SWP?	TIME:RF	6	NR2		0.025	s	Step times of currently activated sweep mode
TIME:CF_SWP?	TIME:CF	6	NR2		0.025	s	
TIME:AF_SWP?	TIME:AF	6	NR2		0.025	s	
TIME:LEVEL_SWP[:RF]?	TIME:LEV:RF	6	NR2		0.025	s	
TIME:MEMORY_SWP?	TIME:MEMORY	6	NR2		0.200	s	
TIME:MEMORY_SWP:FAST?	TIME:MEMORY:FAST	6	NR2		0.002	s	

Explanations:

Polarity sign: + always with polarity sign
 - polarity sign, if negative
 No entry no polarity sign

Format: NR1 digits only
 NR2 digits and decimal point
 NR3 exponents
 HEX hexadecimal digits, beginning with '#H'

*) The unit is not transmitted.

2.4.3.3 Common, Device-independent Setting Commands (Common Commands in Accordance with IEEE 488.2)

Table 2-10

Command	Number, range	Meaning
*RST	---	<p>Reset</p> <p>Acts like key combination Preset (see section "Preset" 2.3.56) and</p> <ul style="list-style-type: none"> switches to messages with header (such as command HEADER :ON), sets the terminator in talker mode to New Line + End. <p>This command does not change the status of the IEC bus interface, the currently set IEC bus address and the registers of the Service Request function.</p>
*PSC	0 or 1	<p>Power On Clear Flag (reset on power-up)</p> <p>If 1: On power-up, Service Request Enable mask register SRE and Event Status Enable mask register ESE are additionally cleared.</p> <p>If 0: The registers mentioned above retain their contents also when the device is switched off and on. This enables a Service Request on power-up of the device.</p>
*OPC	---	<p>Operation Complete</p> <p>Sets bit 0 (Operation Complete) in the Event Status Register when all selected pending device operations have been completed (see section 2.4.6, "Command Processing Sequence and Synchronization").</p>
*CLS	---	<p>Clear Status</p> <p>Sets the Event Status Register ESR to zero. The mask registers of the Service Request function (ESE and SRE) remain unchanged.</p>
*ESE	0 to 511	<p>Event Status Enable</p> <p>The Event Status Enable mask register is set to the specified value which is interpreted as decimal number. *)</p>
*SRE	0 to 255	<p>Service Request Enable</p> <p>The Service Request Enable mask register is set to the specified value which is interpreted as decimal number. *)</p>
*SAV	1 to 50	<p>Save</p> <p>Saves a device setting (see section 2.3.52, "Store-Recall").</p>
*RCL	0 to 50	<p>Recall</p> <p>Recalls a stored device setting (see section 2.3.52, "Store-Recall").</p>
*WAI	---	<p>Wait to Continue</p> <p>Interrupts command execution when all selected pending device operations have been completed (see section 2.4.6, "Command Processing Sequence and Synchronization").</p>

*) see section 2.4.5, "Service Request and Status Registers"

2.4.3.4 Common, Device-independent Data Request Commands (Common Queries in Accordance with IEEE 488.2)

Table 2-11

Data request command	Output message (contains no header)		Meaning
	Max. no. of digits	Range	
*IDN?	27	(alphanumeric)	Identification Query An identification text is sent via the IEC bus in reply to the *IDN? command: ROHDE&SCHWARZ, SMHU52, 0, 1.00 ROHDE&SCHWARZ = Manufacturer SMHU52 = Model (example) 0 = Reserved for serial number (not used with SMHU) 1.00 = Firmware version (example)
*OPT?	1	(alphanumeric)	Option Query Transmits information on the fitted options via the IEC bus. 0: If no option is fitted. B2, 0, 0, 0: If the option 'SMHU-B2 GMSK coder' is fitted. 0, B3, 0, 0: If the option 'SMHU-B3 DECT coder' is fitted. 0, 0, B4, 0: If the option 'SMHU-B4 ADC coder' is fitted. 0, 0, 0, B5: If the option 'SMHU-B5 CT coder' is fitted.
*PSC?	1	0 or 1	Power On Status Clear Query To read the status of the Power on Clear Flag, see *PSC in Table 2-9.
*OPC?	1	1	Operation Complete Query The message "1" is entered into the output buffer and bit 4 (message available) set in the status byte, when all selected pending operations have been completed (see section 2.4.6, "Command Processing Sequence and Synchronization").
*ESR?	3	0 to 511	Event Status Register Query The contents of the Event Status Register ESR is output in decimal form and the register then set to zero.
*ESE?	3	0 to 511	Standard Event Status Enable Query The contents of the Event Status Enable ESE Mask Register is output in decimal form.
*STB?	3	0 to 255	Read Status Byte Query The contents of the status byte is output in decimal form.
*SRE?	3	0 to 255	Service Request Enable Query The contents of the Service Request Enable Mask Register is output in decimal form.
*TST?	2	0 to 69	Self-test Query ROM, RAM and EEPROM tests are performed. The result can be obtained from the output message: 0: no error 61: ROM error 62: RAM error 65: Error in level correction values (EEPROM) 66: Error in local leveling values (EEPROM) 67: Error in SUM1 calibration values (EEPROM) 68: Error in ALC calibration values (EEPROM) 69: Error in I/Q-modulator calibration values (RAM)

2.4.3.5 Examples

(The BASIC commands of the PCAS Controller have been used. The IEC bus address of the SMHU has been taken to be 28).

1) Basic setting

```
IECOUT 28, "*RST" or
IECOUT 28, "PRESET"
```

2) Device identification via IEC bus

```
10 IECTERM 10           (Input terminator: new line)
20 IECOUT 28, "*IDN?"
30 IECIN 28, A$
40 PRINT A$
```

3) RF setting

```
IECOUT 28, "RF 123.456MHz" or
IECOUT 28, "RF 123.456E6" or
IECOUT 28, "RF 123456000"
```

4) RF level setting

All the possibilities as outlined effectuate the same setting.

```
IECOUT 28, "LEVEL 12.5DBM" or
IECOUT 28, "LEV 12.5" or
IECOUT 28, "LEVEL:RF 12.5DBM" or
IECOUT 28, "LEVEL 119.5DBUV" or
IECOUT 28, "LEVEL 0.944V" or
IECOUT 28, "Level 944mV" or
IECOUT 28, "LEVEL 944MV" or
IECOUT 28, "LEVEL:EMF 1.888V"
```

5) Non-interrupting variation of RF level between 2 μ V and 20 μ V in steps of 0.2 dB; stop at each step for 10 ms

```
10 IECOUT 28, "LEVEL 20uV; ATTEN:FIXED; LEVEL 2uV; LEVEL:VAR 0.2"
20 FOR I% = 1 TO 100
30 IECOUT 28, "INCREMENT:LEVEL"
40 HOLD 10
50 NEXT I%
```

The same setting may also be obtained using level sweep:

```
10 IECOUT 28, "SWP:MODE:LEVEL"
20 IECOUT 28, "LEVEL:START 2uV; LEVEL:STOP 20uV"
30 IECOUT 28, "LEVEL:STEP 0.2dB; TIME:LEVEL 10ms"
40 IECOUT 28, "SWP:SINGLE"
```

6) Modulation frequency (AF) and internal frequency modulation setting

```
IECOUT 28, "AF 12.5KHZ; FM:INT 40KHZ"
```

7) External amplitude modulation setting

```
IECOUT 28, "AM:EXT 35.5"
```

8) Storing complete instrument setting in memory location 45

```
IECOUT 28, "**SAV 45"
```

9) Switching off the modulation

```
IECOUT 28, "FM:OFF; AM:OFF"
```

10) Logarithmic RF sweep

```
10 IECOUT 28, "SWP:MODE:RF:LOG"  
20 IECOUT 28, "RF:START 2MHZ; RF:STOP 2GHZ"  
30 IECOUT 28, "RF:LOG_STEP 1PCT; TIME:RF 10ms"  
40 IECOUT 28, "SWP:AUTO"
```

11) Stop sweep

```
IECOUT 28, "SWP:BREAK"
```

12) Reading current RF

```
10 IECTERM 10 (Input terminator "new line")  
20 IECOUT 28, "RF?"  
30 IECIN 28, A$  
40 PRINT A$
```

13) Recalling instrument setting stored in step 8)

```
IECOUT 28, "*RCL 45"
```

2.4.3.6 Syntax of Setting Commands and Data Request Commands (Programming Messages)

Command line

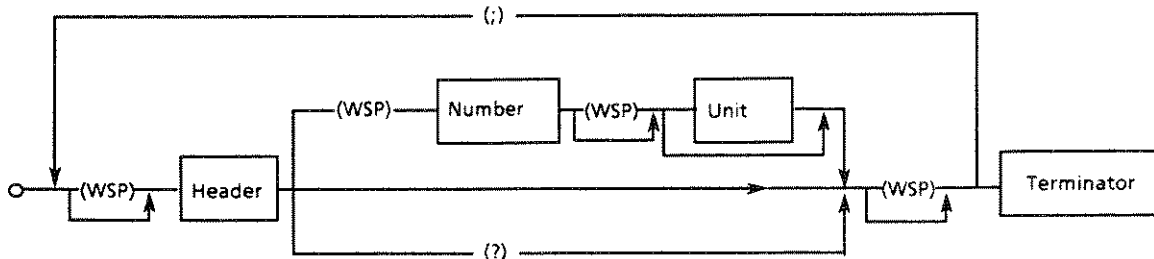

Number

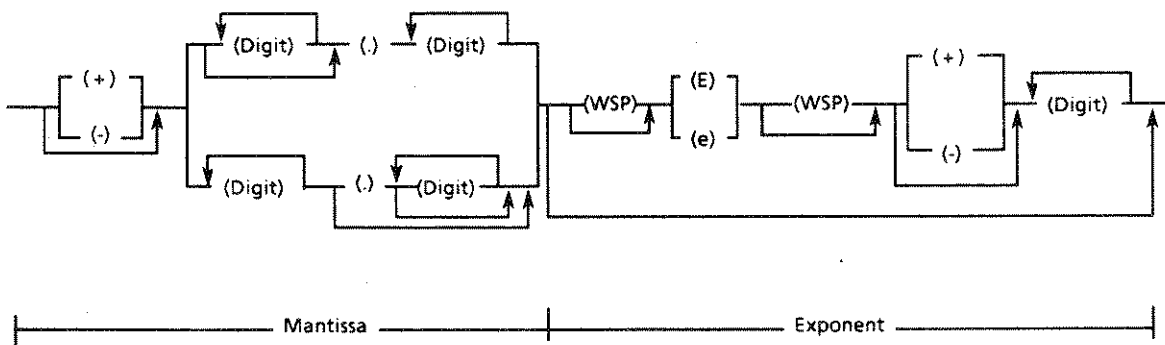

WSP (white space): One or several characters with ASCII code 0 to 9 or 11 to 32 decimal, especially space.

Fig. 2-5 Syntax diagram of a command line (programming message)

Each command line must end with a terminator. Permissible terminators accepted by the SMHU without switchover are:

- * New line (ASCII code 10 decimal)
- * End (EOI line active) together with:
 - ▶ the last useful character of the command line, or
 - ▶ the character "New Line", or
 - ▶ the semicolon (;)

Since the carriage return character (ASCII code 13 decimal) is permissible as an ineffectual filler before the terminator, also the combination of carriage return + new line is permissible.

All IEC bus controllers from Rohde & Schwarz send terminators accepted by the SMHU as standard.

A command line may require more than one line on the screen of the controller because it is only limited by the terminator. Most IEC bus controllers automatically append the terminator to the useful text.

Also, a command line may contain several commands (program message units) to be separated by semicolons (;).

A command may consist of the following parts:

* **Header only**

Example: FM:OFF

* **Header and question mark**

Example: FM?

This combination requests the SMHU to provide the required data in an Output Buffer in order to have them transferred via the IEC bus as soon as the SMHU has been addressed as talker.

* **Header and number**

Example: FM 55E3; FM 55kHz

Header and number are to be separated by at least one space (ASCII code 32 decimal). In the case of device-specific commands, the number can be supplemented by a subsequent unit.

Lower-case letters are permissible, being equivalent to the corresponding upper-case letters. Thus, units can be used in the usual form (e.g. dBm) instead of the upper-case notation (e.g. DBM), which is permissible as well.

Additional spaces may be inserted at the following positions:

- ▶ before a header,
- ▶ between header and number,
- ▶ between mantissa and exponent of the number,
- ▶ between number and unit,
- ▶ before and after a comma (,) and semicolon (;), and
- ▶ before the terminator.

Headers of device-specific commands

The headers are mostly identical with or similar to the respective key designation, which results in easy-to-read (self-documenting) programs.

Two equivalent command notations are possible for special functions:

- ▶ Header 'SPECIAL_FUNCTION' and special function code (as with manual operation)
Example: SPECIAL 1;
- ▶ Special commands with higher documentation value for each individual special function
Example: ATTENUATOR:FIXED;

Some special functions (AF Sawtooth Signal Inverted, Polarity AM SQU Inverted, Polarity FSK Inverted, Internal Two-tone Modulation, Level emf, Phase Offset, Fast Memory Sweep) cannot be directly called up in remote operation via IEC bus. These settings are selected in the respective commands:

AF:WAVEFORM:SAWTOOTH:DOWN, AM:SQUARE:INVERTED, FM:FSK:INVERTED,
AM:DUAL:INTERNAL, LEVEL:EMF, PHASE, SWP:MODE:MEMORY:FAST.

The headers can be abbreviated at will by omitting characters at the end (e.g. LE or LEV instead of LEVEL). The shortest-possible notations are shown in the command tables in bold print. However, so as to obtain easy-to-read programs, the headers should not be too much shortened.

Many headers consist of several parts separated by colons (:) (e.g. LEVEL:OFFSET). Each part of the header may individually be abbreviated in this case (e.g. LEV:OFFS). In accordance with IEEE 488.2 standard, these headers may also comprise a leading colon (e.g. :LEV:OFFS) which, however, does not influence the effects of the commands with the SMHU.

Some headers include the underline character (ASCII code 95 decimal) to improve readability. It must be written like the letters, but always lies in the range that can be omitted by abbreviation ¹⁾.

Numbers

Only decimal values are allowed as numbers, the following notations being permissible:

- * With or without polarity sign,
e.g. 5, +5, -5
- * With or without decimal point, any position of the decimal point being permissible,
e.g. 1.234, -100.5, .327
- * With or without exponent to base 10, "E" or "e" are used as the exponent character,
e.g. .451, 451E-3, +4.51e-2
- * The exponent is permissible with or without sign, additional spaces are also permissible,
e.g. 1.5E +3, 1.5E-3, 1.5E 3
- * Leading zeros are permissible in mantissa and exponent,
e.g. +0001.5, -01.5E-03
- * The length of the number, including the exponent, may amount up to 20 characters. The number of digits for the mantissa and exponent is only limited by this condition. Digits which exceed the resolution of the device are rounded up or down; they are always considered for the order of magnitude (power of ten).
e.g. 150000000, 0.00000032

Note: Specification of the exponent alone (e.g. E-3) is not permissible, but 1E-3 is correct.

All setting commands that can be assigned a number are indicated in the number column in Table 2.7.

Unit

Device-specific setting commands permit to append a unit to the number (e.g. 125.3 kHz or 125.3E3 Hz). The permissible units are listed in Table 2-7 (Table of device-specific setting commands). They can be written in lower-case or upper-case letters. If no unit is used, the default unit is valid, see Table 2-7.

¹⁾ The underline character is generated using the "←" key on the R&S Controllers PCA and PUC.

2.4.3.7 Data Request and Syntax of the Messages Sent by the SMHU in Talker Mode to the Controller (Response Messages)

The SMHU Signal Generator sends messages via the IEC bus if it

- 1) has been requested by one or more²⁾ data requests (query messages) with a question mark to provide data in its Output Buffer, and
- 2) indicates by setting bit 4 (MAV - message available) in the status byte that the requested data are now present in the Output Buffer (cf. section "Service Request and Status Registers"), and
- 3) has been addressed as a talker
(BASIC command "IECIN adr, stringvariable").

Note that the command line with the data requests must be transmitted immediately before the talker is addressed. The Output Buffer is cleared if a further command line is entered in between.

If the SMHU is addressed as a talker immediately following the data request without observing item 2 as mentioned above, the bus handshake is blocked until the requested data are available. This is useful with the SMHU Signal Generator since the execution of a data request only requires several milliseconds (see program example outlined in the following).

Program example:

Stop RF sweep at any arbitrary position of sweep and read current frequency.
(BASIC commands of PCA 5; address of the SMHU has been set to 28.)

10 IECTERM 10	Input terminator: new line
20 IECOUT 28, "*RST"	Reset, set message with header
30 IECOUT 28, "SWP:MODE:RF:LIN; SWP:SINGLE"	Start sweep
50 IECOUT 28, "SWP:BREAK; RF?"	Stop sweep, data request RF frequency
60 IECIN 28, F\$	Talker addressing and reading data
70 PRINT F\$	RF frequency indicated on controller, e. g.: "RF 123456789.0"

-
- 2) Several data requests must be within one line if the SMHU is to transmit all the relevant messages at a time.

The syntax of messages sent by the SMHU is shown in Fig. 2-6. It is similar to that for commands received by the SMHU.

Output message line

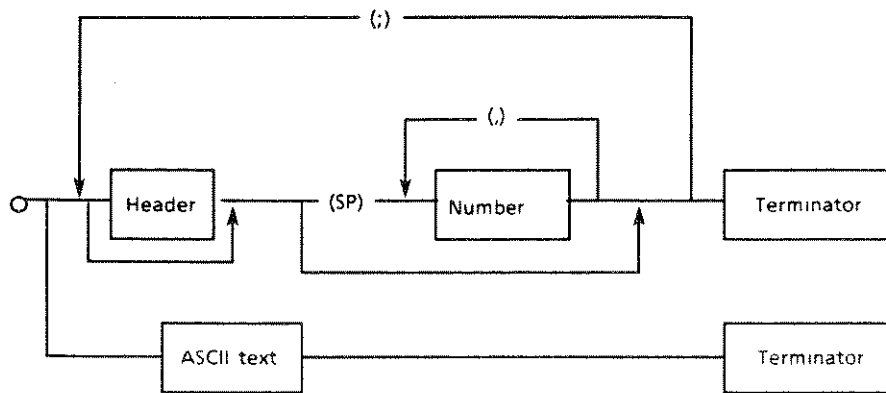

Number, NR1 format

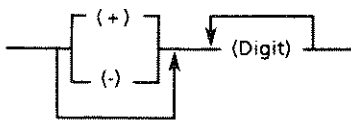

Number, NR2 format

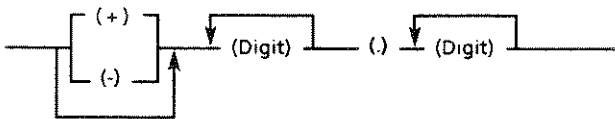

SP: Space (ASCII code 32 decimal)

ASCII text: Response to commands *IDN? and *OPT? (see Table 2-10)

Fig. 2-6 Syntax diagram of messages sent by the SMHU in talk mode

- * "New Line" (ASCII code 10 decimal) together with "END" (EOI line active) is used as the terminator. It is also possible to set "Carriage return + new line + end" (using command TALK_TERMINATOR:CR_NLEND).
- * The commands "HEADER:ON" or "HEADER:OFF" can be used to select whether only the numbers or the header and the numbers are to be transmitted.

The setting "header and numbers" can also be selected by:

- ▶ using the command *RST (Reset), or
- ▶ switching on the operating voltage.

The setting "header and numbers" allows the messages transmitted by the SMHU to be returned again to the device in the same form, without any amendments, as setting commands. It is thus possible to read a setting entered via the keyboard, store it in the controller and repeat it later via the IEC bus.

- * If the SMHU receives several data requests, it also returns several messages within one line which are separated by semicolons (;).
- * Header and numbers are always separated by a space.
- * The headers only consist of upper-case letters and character ":".
- * The syntax of the numbers is shown in Fig. 2-6. Only decimal numbers are transmitted. The length of the numbers is not constant but depends on the current quantity of the number to be transmitted. (To remain in accordance with IEEE-488.2, leading spaces are not permissible). The maximal length as well as examples for each message are outlined in Table 2-8 and Table 2-10.
- * Several numbers can be transmitted in response to the commands SPECIAL_FUNCTION? and ERRORS?, which are separated by comma (,).
- * The messages sent by the SMHU contain no units. In the case of physical quantities, the numbers are referred to the basic unit specified in Table 2-8.

2.4.3.8 Alternative Commands and Notations

To obtain a high degree of compatibility with regards to Rohde & Schwarz instruments of earlier production dates, the SMHU features alternative commands and also accepts notations of a different syntax. The following table specifies both possibilities with the SMHU, which are identical as to their effects.

Table 2-12

Preferred notation (in accordance with IEEE-488.2)	Alternative notation
*SAV value *RCL value	STORE value RECALL value
HEADER:ON HEADER:OFF	* HDR 1 * HDR 0
Unit per cent: PCT	%
Units as indicated in the command tables	Units may be abbreviated (like header): Hz, KHz, MHz, GHz, S, Ms, Us, Pct, V, MV, Uv, DBM, DBUv, DB, DEG, RAD
Separation between commands: semicolon (;)	Comma (,)
Separation between header and number: space	No separation character required
DM:... (Command for digital modulation)	GMSK:...

2.4.4 Interface Messages

Interface messages (in accordance with IEC 625-1 and IEEE 488) are transmitted to the SMHU on the data lines, in which case the Attention line is active (low).

2.4.4.1 Universal Commands

The universal commands have codes between 10 and 1F hexadecimal (see Table 2-14). They are effected for all the devices connected to the bus, without these devices being individually addressed before.

Table 2-13

Command	BASIC command with R&S controllers	Effect on the SMHU
DCL (Device Clear)	IECDCL	Aborts processing of the currently received commands and sets the command processing software to a defined initial status. Clears the Output Buffer. The device setting is not changed.
LLO (Local Lockout)	IECLLO	The LOC key is disabled.
SPE (Serial Poll Enable)	IECSPE ¹⁾	Ready for serial poll.
SPD (Serial Poll Disable)	IECSPD ¹⁾	End of serial poll.

- 1) The BASIC command "IECSPL adr, status" contains the commands "IECSPE" and "IECSPD" and additionally reads the status of the device with address "adr" and stores this in the integer variable "status".

2.4.4.2 Addressed Commands

The addressed commands have codes between 00 and 0F hexadecimal (see Table 2-14). They only act on devices currently addressed as listeners (BASIC command "IECLAD adr").

Table 2-14

Command	BASIC command with R&S controllers	Effect on the SMHU
SDC (Selected Device Clear)	IECSDC	Aborts processing of the currently received commands and sets the command processing software to a defined initial status. Clears the Output Buffer. The device setting is not changed.
GTL (Go To Local)	IECGTL	Change to local status (manual operation).
GET (Group Execute Trigger)	IECGET (PCA) IECGXT (PUC)	If manual fast memory sweep mode is selected, the next memory is accessed.

ASCII/ISO and IEC Character Set

Table 2-15

Control					Numbers Symbols				Upper case				Lower case				
0	NUL		16	DLE		32	SP	48	0	64	@	80	P	96	.	112	p
1	SOH	GTL	17	DC1	LLO	33	!	49	1	65	A	81	Q	97	a	113	q
2	STX		18	DC2		34	"	50	2	66	B	82	R	98	b	114	r
3	ETX		19	DC3		35	#	51	3	67	C	83	S	99	c	115	s
4	EOT	SDC	20	DC4	DCL	36	\$	52	4	68	D	84	T	100	d	116	t
5	ENQ	PPC	21	NAK	PPU	37	%	53	5	69	E	85	U	101	e	117	u
6	ACK		22	SYN		38	&	54	6	70	F	86	V	102	f	118	v
7	BEL		23	ETB		39	'	55	7	71	G	87	W	103	g	119	w
8	BS	GET	24	CAN	SPE	40	(56	8	72	H	88	X	104	h	120	x
9	HT	TCT	25	EM	SPD	41)	57	9	73	I	89	Y	105	i	121	y
10	LF		26	SUB		42	*	58	:	74	J	90	Z	106	j	122	z
11	VT		27	ESC		43	+	59	;	75	K	91	[107	k	123	{
12	FF		28	FS		44	,	60	<	76	L	92	\	108	l	124	
13	CR		29	GS		45	_	61	=	77	M	93]	109	m	125	}
14	SO		30	RS		46	.	62	>	78	N	94	^	110	n	126	~
15	SI		31	US		47	/	63	? UNL	79	O	95	-	111	o	127	DEL
Addressed commands			Universal commands		Listener addresses				Talker addresses				Secondary addresses and commands				

Key:

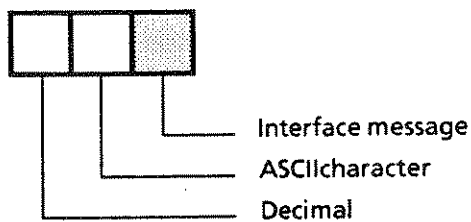

2.4.5 Service Request and Status Registers

Fig. 2-7 shows the status registers and the links effective between them. To remain in accordance with the IEEE 488.2 standard, the status byte (STB) and its associated mask register (SRE), which are also present with devices of earlier production dates, have been supplemented by the Event Status Register (ESR) and its Event Status Enable Mask Register (ESE).

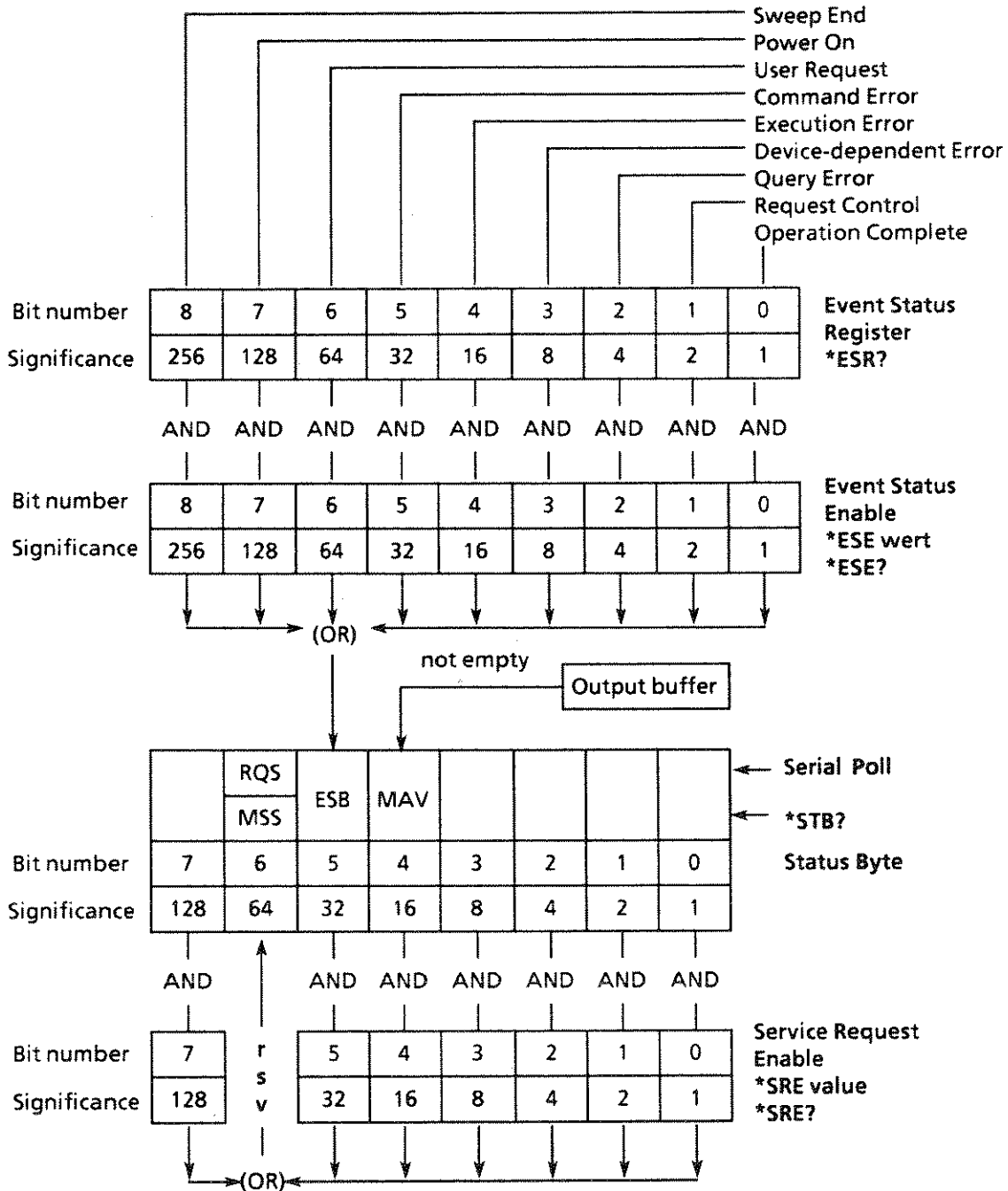

Fig. 2-7 Status registers

Table 2-15 Bit allocation of the Event Status Register ESR

Bit number	Meaning
8	<p>Sweep End</p> <p>Is set when the stop mark is reached in a single sweep.</p>
7	<p>Power On</p> <p>Is set when the SMHU is switched on or when the power returns following a failure.</p>
6	<p>User Request</p> <p>The user can set this bit by activating special function 62 (in the local status via the keyboard) and thus generate a Service Request if the mask registers are set accordingly. This function is useful in test routines require manual operation as well as control via the IEC bus</p> <p>This bit can also be set by a signal (positive edge) at the trigger input if special function 41 is activated. This allows a service request by events (logic signals) from outside.</p>
5	<p>Command Error</p> <p>Is set if a syntax error is detected during analysis of the received commands. It includes the following errors:</p> <ul style="list-style-type: none"> • General syntax error (ERROR 20) • Illegal header (ERROR 23) • Illegal unit (ERROR 24)
4	<p>Execution Error</p> <p>Is set if an error is detected during execution of the commands received (ERROR 1 to 5, 9 to 13, 21, 22, 25, 26, 29, 30)</p>
3	<p>Device-dependent Error</p> <p>Is set upon occurrence of functional errors (ERROR 40 to 74) and if the external modulation signal is outside the tolerance range (ERROR 7 and 8).</p>
2	<p>Query Error</p> <p>This bit is set:</p> <ul style="list-style-type: none"> • if the controller wants to read data from the SMHU without having output any query message before. • if the data present in the Output Buffer of the SMHU have not been read out and instead, a new command line is sent to the SMHU. The Output Buffer is cleared in this case. • If the requested data are beyond the capacity of the Output Buffer.
1	<p>Request Control</p> <p>Not used in SMHU.</p>
0	<p>Operation Complete</p> <p>This bit is set by the command *OPC if all selected pending operations have been completed.</p>

A bit is set to 1 in the **Event Status Register ESR** in the case of certain events (e.g. error, ready signal), see Table 2-15.

These bits remain set until cleared by one of the following conditions:

- * by reading the Event Status Register (using the command *ESR)
- * using the command *CLS
- * by switching on the ac supply (the power-on bit is set in this case).

Using the **Event Status Enable Mask Register (ESE)**, the user can select the bits in the ESR which also set the sum bit ESB (bit 5 in the status byte) via which a Service Request can be triggered. The sum bit is therefore set only if at least one bit in the ESR and the corresponding bit in the ESE are set to "1". The sum bit is automatically cleared again if the above condition is no longer fulfilled, e.g. if the bits in the ESR have been cleared by reading the ESR or if the ESE has been modified.

The Event Status Enable Mask Register is written to by the command *ESE value" (value is the contents in decimal form) and can be read again by the command *ESE?. It is set to "0" upon switch-on of the ac supply if the power-on-clear flag is "1" (*PSC 1).

The ESE Mask Register is not changed by other commands or interface messages (DCL, SDC).

Only the bits listed in the following table are used in the status byte (STB):

Bit number	Bus line	Designation	Meaning
4	DIO 5	MAV	Message Available Indicates that a message is present in the Output Buffer which can be read. The bit is "0" if the Output Buffer is empty.
5	DIO 6	ESB	Sum bit of the Event Status Register
6	DIO 7	RQS MSS	Request Service (read by Serial Poll) Master Status Summary (read by *STB?)

Note that the bits of the status registers are numbered from 0 to 7 in compliance with IEEE 488.2 standard, but that the bus data lines are designated DIO 1 to DIO 8.

Using the **Service Request Enable mask register (SRE)**, the user can determine whether the RQS bit of the status byte is also set when the MAV or ESB bit changes from 0 to 1, and whether a Service Request is sent to the controller by activating the SRQ line. Since each bit in the SRE mask register is assigned to the corresponding bit in the status byte, the following possibilities exist:

Contents of SRE (decimal)	Set bit No. in SRE	Effect
0	--	no Service Request
16	4	Service Request if the MAV bit is set (message in Output Buffer).
32	5	Service Request if the ESB bit is set (at least 1 bit in the Event Status Register is set and not masked).
48	4 + 5	Service Request in the above two cases.

The Service Request Enable Mask Register (SRE) is written to by the command *SRE value" (value is the contents in decimal form) and can be read again using the command *SRE?. It is set to "0" upon switch-on of the ac power if the power-on-clear flag is "1"; the Service Request function of the SMHU is thus disabled. The SRE mask register is not changed by other commands or interface messages (DCL, SDC).

Several devices can trigger a Service Request simultaneously; the open collector drivers generate an OR function on the SRQ line. The controller must read the status bytes of the devices in order to identify the device which has triggered the Service Request. A set RQS bit (bit 6/DIO7) indicates that the device sends a Service Request.

The status byte of the SMHU can be read in the following ways:

- * by means of command "*STB?".

MSS (Master Status Summary) is transferred as bit 6. MSS is 1 if at least 1 bit is set in the status byte and the corresponding bit in the SRE Mask Register is also set.

The contents of the Status Byte (including MSS bit) is output in decimal form. It is, however, not possible to determine a set MAV bit in this way. The status byte is not changed by reading out, and a present Service Request is not cleared.

- * by means of a Serical Poll.

(With R&S controllers: IEC SPL adr, status.)

The contents is transferred in binary form as *one* byte. RQS (Request Service) is sent as bit 6. RQS is set if the device addressed has triggered the Service Request. The RQS bit is then set to "0" and the Service Request becomes inactive; the other bits of the status byte are not changed.

RQS is also cleared if MSS is cleared, e.g. by setting the SRE Mask Register to 0.

The status byte is cleared:

- * by means of *CLS at the beginning of a command line.

The Output Buffer (and thus the MAV bit) is cleared at the beginning of a command line. *CLS clears the ESR (and thus the ESB bit). This in turn clears the MSS or RQS bit and the Service Request message.

- * by handling the entries in the status byte:

with the MAV bit set:	by reading the contents of the Output Buffer (IEC IN adr, AS)
with the ESB bit set:	by reading the Event Status Register (IEC OUT adr, "**ESR?" IEC IN adr, ES).

This also clears the MSS or RQS bit in the Status Byte and the Service Request.

In the second example a service request is set off by a signal at the trigger input of the SMHU while a sweep is being executed. The controller reads out the current frequency. The sweep serves to search for spurious responses of receivers. (The trigger signal is generated by the receiver). In addition, at the end of the sweep a service request is set off.

```

10 IECTERM 10
20 ON SRQ GOSUB 100
30 IECOUT28, "*CLS: *ESE 320; *SRE 32"; SPECIAL 41"
40 IECOUT28, "SWP:MODE:RF:LIN"
50 IECOUT28, "RF:START 1MHz; RF:STOP 2GHz"
60 IECOUT28, "RF:STEP 5 kHz; TIME:RF_SWP 10ms"
70 IECOUT28, "SWP:SINGLE"
80 X = 0
90 GOTO 80
100 REM -----
110 REM  SERVICE REQUEST ROUTINE
120 REM -----
130 IEC SPL 28, S%
140 IF (S% AND 64) = 0 THEN GOTO 230
150 IECOUT28, "*ESR?"
160 IECIN28, E$
170 E% = VAL(E$)
180 IF (E% AND 256) <> 0 THEN PRINT "Sweep ended" : STOP
190 IF (E% AND 64) = 0 THEN GOTO 230
200 IECOUT28, "RF?"
210 IECIN28, F$
220 PRINT "RF= "; F$; "Hz"
230 ON SRQ GOSUB 100
240 RETURN

```

Input terminator: new line
 for Service Request at Sweep End or due to a trigger input (User Request)
 Select and start Sweep
 Wait loop
 SRQ not from SMHU
 Read and evaluate Event Status Register
 Read out current frequency

2.4.6 Command Processing Sequence and Synchronization

The Generator features a maximal transmission rate of 19 000 characters/sec. for receiving of data. The received commands are first stored in an Input Buffer, which can accommodate a maximum of 150 to 170 characters. Once the terminator has been received, the commands are processed in the sequence in which they were sent. During this time, the IEC bus can be used for communication with other devices.

Command lines which exceed the capacity of the Input Buffer are processed in several parts. The bus is occupied during this time.

The commands *OPC and OPC? (Operation Complete) are used as feedback information indicating the time when processing of the received commands is terminated and the output signal of the SMHU has settled on the new values:

- ▶ *OPC sets bit 0 in the Event Status Register,
 - ▶ *OPC? provides the message "1" in the Output Buffer and sets bit 4 (MAV) in the status byte,
- if all selected pending operations have been completed.

If the Service Request Enable Register (SRE) or the ESE for command *OPC are appropriately set, both command *OPC and command *OPC? can trigger a Service Request.

The command *OPC allows for a simplified method of synchronization, see the program example outlined below.

This method of synchronization is recommended if another device, which requires the settled signal of the SMHU, is to be requested to start a measurement via the IEC bus.

Following *WAI, the SMHU does not process the new commands until all preceding commands have been completely executed and the output signal of the SMHU is exactly settled. Thus, overlapping command execution, which may occur only in the following exceptional cases, can be avoided.

With the majority of the commands, no additional settling time is required for the output signal following command processing. The only exceptions are:

- Switching of the mechanical attenuator (initiated by changing the level or switching on the AM)
- Switchover of reference frequency
- Switching on broadband FM (only with SMHU.58)
- Switching on digital modulation with the PRBS generator off (only with the options SMHU-B2, SMHU-B3 or SMHU-B4)

The additional settling time then required is automatically taken into consideration when commands *OPC, *OPC? or *WAI are used.

Program example:

The program example shows an easy method of synchronization. The command *OPC? generates a message as soon as the preceding commands are executed and the output signal of the SMHU is settled. Since this message is to be read in line 30, the bus handshake is halted until the message is available. (BASIC commands of PCA5; SMHU address 28).

```
10 IECTERM 10           Input terminator: new line
20 IECOUT 28, "RF 123MHZ; LEV 11.5DBM; *OPC?"
30 IECIN  28, A$       A$ not used further
40 REM   The SMHU has executed
45 REM   the commands in line 20.
50 REM   Its output signal is settled
55 REM   and can be used e.g. for measurements.
```

2.4.7 Error Handling

Any errors detected by the SMHU in connection with operation via the IEC bus are indicated by setting a bit (bit 2, 4 or 5) in the Event Status Register (see Table 2-9). Functional errors are signalled by setting bit 3. These bits remain set until the ESR is read or cleared by the command *CLS. This is in line with the IEEE 488.2 standard and enables triggering of a Service Request and program-controlled evaluation of the type of error (see first program example as outlined at the end of section 2.4.5).

More detailed information is contained in the error codes which, just like with keyboard operations, are read out in the MODULATION/AF display. The display is overwritten by the next command, however, and is therefore not always visible with IEC bus operation. It is therefore possible to have these error codes read out via the IEC bus using command 'ERRORS?'. If several errors are detected, the error codes are separated by commas. Code "0" indicates that no errors are currently detected. Input errors (codes 20 to 31) are cleared following readout and by means of command *RST. All other errors are indicated as long as the cause for error has not been removed.

2.4.8 Resetting of Device Functions

The following Table lists the various commands and events which cause individual device functions to be reset.

Effect	Event					
	Switching on the operating voltage		DCL, SDC (Device Clear, Selected Device Clear)	Commands		
	Power-On-Clear-Flag			*CLS	*RST	PRESET
	0	1				
Basic device setting (see section "Preset", 2.3.56)	--	--	--	--	yes	yes
Set Event Status Register ESR to zero	yes	yes	--	yes	--	--
Set mask registers ESE and SRE to zero	--	yes	--	--	--	--
Clear Output Buffer	yes	yes	yes	2)	2)	2)
Delete Service Request	yes	1)	--	2)	--	--
Messages from the SMHU: Setting "HEADER:ON", Talker terminator New Line + End	yes	yes	--	--	yes	--
Reset command processing and Input Buffer	yes	yes	yes	--	--	--

1) Yes, but "Service Request on power on" is possible.

2) Yes, if command is positioned at the beginning of a command line.

2.4.9 Local/Remote Switchover

The device is always in the local status when switched on (manual operation).

If the SMHU is addressed by a controller as a listener (using the BASIC commands IECOUT or IECLAD in the case of R&S controllers), it enters the remote status (remote control) in line with the standard and remains in this mode even after data transfer has been completed. The REM LED is continuously illuminated to indicate remote control status. All controls on the front panel except the LOCAL key are disabled.

There are two possibilities how to return to the local status:

- * with the addressed command **GTL** (Go to Local) from the controller.
- * by pressing the **LOCAL** key. Data output from the controller to the SMHU should be stopped before pressing the LOCAL key since otherwise the SMHU will immediately return to the remote status again. The function of the LOCAL key can be disabled by the controller sending the universal command **LLO** (Local Lockout).

The other device settings are not modified when switching from Remote to Local or vice versa.

2.4.10 Interface Functions

According to the IEC 625-1 standard, devices which can be remote-controlled via the IEC bus can be equipped with different interface functions. The following table lists the interface functions valid for the SMHU:

Abbreviation in accordance with IEC 625-1	Interface functions
SH1	Source Handshake, full capability
AH1	Acceptor Handshake full capability
L4	Listener, full capability, unaddress if MTA
T6	Talker, full capability, capability to reply to serial poll, unaddress if MLA
SR1	Service Request, full capability
PP0	Parallel Poll, not available
RL1	Remote/Local switchover, full capability
DC1	Device Clear, full capability
DT1	Device Trigger, full capability
C0	Controller, not available

2.4.11 IEC Bus Connector and Bus Lines

The IEC bus connector is positioned on the rear panel of the instrument. The SMHU is equipped with a 24-contact socket in compliance with the IEEE 488 standard.

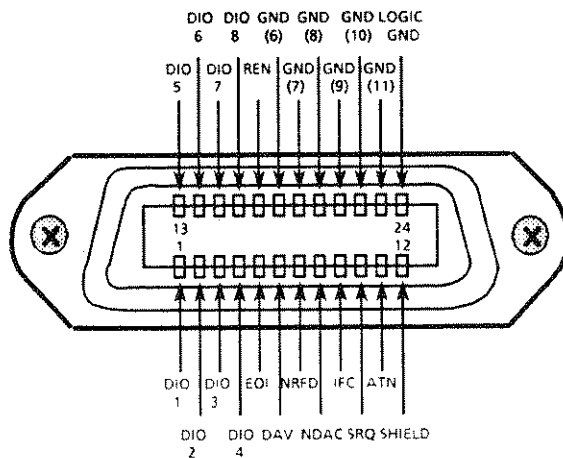

Fig. 2-8 Pin assignment

The standardized interface contains three groups of bus lines:

1) **Data bus with 8 lines DIO 1 to DIO 8.**

Data transmission is bit-parallel and byte-serial with the characters in ISO-7 bit code (ASCII code).

DIO 1 represents the least significant and DIO 8 the most significant bit.

2) **Control bus with 5 lines.**

This is used to transmit control functions:

ATN (Attention)
becomes active Low when addresses, universal commands or addressed commands are transmitted to the connected devices.

REN (Remote Enable)
enables the device to be switched to the Remote status.

SRQ (Service Request)
enables a connected device to send a Service Request to the controller by activating this line.

IFC (Interface Clear)
is activated by the controller in order to set the IEC interfaces of the connected devices to a defined status.

EOI (End or Identify)

can be used to identify the end of data transfer and is used with a parallel poll.

3) **Handshake bus with 3 lines**

The handshake bus is used to control the data transfer sequence.

NRFD (Not Ready For Data)

An active Low on this line signals to the talker/controller that one of the connected listener devices is not ready to accept data.

DAV (Data Valid)

is activated by the talker/controller shortly after a new data byte has been applied to the data bus.

NDAC (Not Data Accepted)

is held at active Low by the connected device until it has accepted the data present on the data bus.

Detailed information on the data transfer sequence is available in the IEC 625-1 standard.

2.5 Options

In addition to the standard equipment, the following coders are available as options for the SMHU.58:

SMHU-B2 GMSK Coder
SMHU-B3 DECT Coder
SMHU-B4 ADC Coder
SMHU-B5 CT Coder

For more detailed information please refer to the data sheet as well as to the service manual.

Retrofitting the Options SMHU-B2/3/4/5:

Check the software status using SF 71. For software versions older than 3.0 on the coders GMSK, DECT and ADC, and for versions older than 4.0 on the CT coder, the EPROMs on the controller module must be replaced by the EPROM set supplied with the option. For versions 3.0 or later (4.0 with CT coder), only the coder must be fitted.

- Loosen the four countersunk screws in the rear feet and remove them. Slide the two instrument covers to the rear and then remove them. Untighten the two screws on the locking rails and slide them toward the front panel. If the EPROMs must be replaced, withdraw the controller board (1st board behind the front panel); the cables need not be removed. Withdraw the screws of the protection shield and replace the EPROMs at the positions D135 and D140. Refit the shield and mount the board; take care of the ribbon cables during this procedure.
- Pull out the SMB cable on the bottom side of the broadband modulator (last board in front of the power supply), withdraw the board and the protection shield. Remove the screws from the fixing blocks of the coder. The optional coder is fitted into the left chamber above the four SMB sockets. Hook the option in the hole in the shielding wall using a headless screw, plug on the connector, fit the module into place and fasten the screw into the fixing block opposite of the headless screw. Make sure that the choke L515 on component side of the broadband modulator is not damaged during assembly. It must now be possible to swivel the coder. Make sure that there are no short-circuits relating to the test points on the broadband modulator. Subsequently fix the coder using the second screw and fit the protection shield to the broadband modulator. Insert the module and connect the SMB cables in the correct order (labelling to the motherboard). The reassembling of the instrument is carried out in the reverse order to that of removal as described above.
- Switch on the instrument, the option display OP. 2/3/4/5 must be visible. Subsequently calibrate the I/Q modulator using SF 320; no error message must be indicated afterwards. The present calibration data are not influenced when replacing the EPROMs.
- Adjust the coder in accordance with the Service Manual.

3 Maintenance

3.1 Required Equipment

Item	Equipment	Required specifications	R & S equipment	Use described in section
1	Frequency counter	1 Hz to 4.32 GHz resolution 0.1 Hz	included in FSB	3.2.4 / 30
2	RF spectrum analyzer AF spectrum analyzer	100 Hz to 5 GHz, synthesizer tuning, dynamic range 100 dB 100 Hz to 1 MHz, sensitivity 0.2 μ V	FSB	3.2.3 / 6 / 7 / 8 / 13 / 21 / 23 / 24
3	Storage oscilloscope		BOS	3.2.3
4	Controller	With IEC 625/IEEE 488 interface, BASIC	PCA 5	3.2.3
5	Signal generator with high spectral purity	0.1 MHz to 4.32 GHz, SSB noise level < -130 dBc at 1 GHz/20 kHz	SMHU	3.2.7 / 8 / 10 / 13 / 15 / 18 / 19 / 20 / 22 / 25 / 26 / 27 / 29 / 32 / 33 / 34
6	Phase noise test setup	Mixer 10 MHz to 4.32 GHz, lowpass 1.5 MHz, preamplifier with 40-dB selector, input noise < 2 nv (1 Hz)		3.2.7 / 8
7	Oscilloscope	Laboratory oscilloscope, dual-channel with dc coupling	BOL	3.2.7 / 8 / 16 / 23 / 31
8	RF power meter	100 kHz to 4.32 GHz	NRV	3.2.11 / 14
9	Precision attenuator	0 to 120 dB, resolution 0.1 dB	DPSP	3.2.12
10	Test receiver	100 MHz, sensitivity < 0 dB μ V	ESV	3.2.12
11	Directional coupler	Up to 4.32 GHz Directivity > 35 dB Coupling attenuation > 10 dB		3.2.13
12	Adjustable dc voltage source	0 to 10 V	NGT 20	3.2.15 / 21
13	RF power amplifier	10 MHz to 4.32 GHz, power > 1 W		3.2.15
14	Audio analyzer	Generator up to 100 kHz, level meter, distortion meter	UPA	3.2.10 / 16 / 17 / 18 / 19 / 20 / 22 / 25 / 26 / 27 / 29 / 32 / 33 / 34
15	Modulation analyzer	100 kHz to 1.36 GHz, AM, FM, Φ M, error < 1 %	FAM	3.2.10 / 18 / 19 / 20 / 22 / 25 / 26 / 27 / 28 / 29 / 31 / 32 / 33 / 34 /
16	Mixer	10 MHz to 4.32 GHz, high level		3.2.10 / 18 / 19 / 20 / 22 / 25 / 26 / 27 / 29 / 32 / 33 / 34
17	Pulse generator	Pulse repetition frequency up to 10 MHz, TTL level		3.2.23 / 24 / 31
18	Sampling oscilloscope	Bandwidth > 2 GHz		
19	RF Spectrum analyzer	Up to 22 GHz, Dynamic range > 70 dB	FSB	3.2.5

Required Equipment for SMHU58:

Item	Equipment	Required specifications	R & S equipment	Use described in section
20	Frequency divider ÷ 100	$f_{MAX} > 1 \text{ GHz}$		3.2.39 / .40
21	Generator	$f = 20 \text{ Hz to } 20 \text{ MHz}$ $R_i = 50 \Omega$ $U_o > 2 V_p \text{ into } 50 \Omega$	AFG AFGU	3.2.39 / .42
22	Vector voltmeter	$U_{in} = 0.3 \text{ mV to } 1 \text{ V}$ $f = 20 \text{ Hz to } 20 \text{ MHz}$	ZPV with E1	3.2.42
23	Power splitter, ohmic	$f = \text{DC to } 300 \text{ MHz}$	RVZ	3.2.42
24	Power splitter, (on basis of transformer)	$f = 10 \text{ to } 300 \text{ MHz}$	DVS	3.2.42
25	Mixer	$f = 10 \text{ to } 300 \text{ MHz}$ normal level		3.2.42
26	Attenuators	3, 6, 10, 20 dB	DSF	3.2.42
27	Feed-through termination	50Ω	RAD	3.2.42
28	Voltage source with two channels	$U_o = 0 \text{ to } 10 \text{ V}$ $U_{offs} < 10 \text{ mV}$ $U < 10 \text{ mV}$	NGPS	3.2.48 / .51
29	Voltage divider ÷ 10	$R_i = 50 \Omega$		3.2.48 / .51
30	Network analyzer	$f = 140 \text{ MHz}$ suitable for vector measurements with polar indication		3.2.48 / .51
31	Clock generator	$\Delta f < 5 \cdot 10^{-6}$, 24 to 1200 kHz TTL level		3.2.52 / .55 / .58
32	Modulation analyzer	ΦM with weighting bandwidth 10 Hz to 300 KHz		3.2.53
33	AC Voltmeter	10 Hz to 20 MHz	URE3	3.2.56

3.2 Testing the Rated Specifications

The measured values and tolerances listed below do not take the accuracy of the measuring instruments display into consideration.

Model SMHU 52/56:

3.2.1 Displays and Keyboard

Special function 72 (display test) can be used to switch on all displays and LEDs for checking purposes. The keyboard can be checked by noting the response on the displays when keys are pressed.

3.2.2 Frequency Setting

The frequency setting can be checked using a frequency counter (3.1, item 7) whose reference frequency is synchronized with that of the SMHU.

SMHU settings:

Test frequency, unmodulated, level 0 dBm

- Recommended test frequencies:
1000 MHz, 1010 MHz, 1020 MHz, 1030 MHz, 1040 MHz, 1399 MHz, 1401 MHz, 1799 MHz, 1801 MHz, 2160 MHz, 2520 MHz, 3240 MHz, 3960 MHz, 4320 MHz, 800 MHz, 600 MHz, 400 MHz, 300 MHz, 200 MHz, 150 MHz, 100 MHz, 75 MHz, 50 MHz, 37 MHz, 25 MHz, 19 MHz, 10 MHz.
- Switch on special function 21 (125 MHz heterodyne band), recommended test frequencies:
124.999999 MHz / 100 MHz / 10 MHz.

The accuracy of the measured values must be of the same magnitude as the counter resolution.

3.2.3 Settling Time

A crystal-based spectrum analyzer with video output (3.1, item 2) in combination with a storage oscilloscope (3.1, item 3) is suitable for measuring the settling time. The spectrum analyzer is operated as an edge demodulator with a 0-Hz span. Start and stop frequencies are sent from a controller (3.1, item 4) via the IEC bus. The storage oscilloscope is connected to the video output of the analyzer and triggered by the positive edge on the EOI line of the IEC bus.

If the controller now switches from the start frequency to the stop frequency, the settling process appears on the screen of the storage oscilloscope.

Test setup:

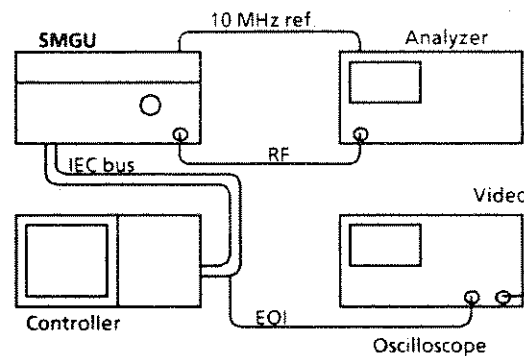

Fig. 3-1

Preparation:

- Synchronize the reference frequencies of the SMHU and analyzer.
- Establish the IEC bus and RF connections, connect the storage oscilloscope to the video output of the analyzer, link the trigger connection to the EOI line (pin 5) of the IEC bus.
- Set the stop frequency, unmodulated with a level of 0 dBm, on the SMHU.
- Set the time base to 2 ms/div on the storage oscilloscope, and a suitable sensitivity for the video output of the analyzer. Set cyclic triggering for the calibration, and external triggering by the positive edge at approx. 1.5 V for the measurement.
- Set the reference level on the spectrum analyzer to -5 dBm, the amplitude scale to 1 dB/div, the resolution bandwidth to 10 kHz, the video bandwidth to 1 MHz and the span to 100 kHz.
- Now increase the center frequency, starting from the end frequency, until the visible filter edge passes through the center of the screen.

- Now reduce the span to 0 Hz and calibrate the frequency scale on the (free-running) oscilloscope by means of 100-Hz steps on the SMHU.

Test procedure:

- First the start frequency and then the stop frequency is sent from the controller. The settling curve appears on the screen of the externally triggered oscilloscope. The relative deviation from the nominal frequency after 10 ms must be less than 1 E-6.

Recommended test frequencies:

999 to 1001 MHz
 1000 to 2160 MHz
 1399 to 1401 MHz
 1799 to 1801 MHz
 1000 to 1040 MHz
 2150 to 2170 MHz

It is sufficient to measure frequencies in the upper octave, since all other frequencies are generated from these by division, mixing or doubling.

BASIC program for the controller:

```
10 SMHU = 28: IECTERM 1
20 IECDC: HOLD 500
30 IECOUT SMHU, "LEV 0DBM"
40 INPUT "Start frequency in MHz"; F1$
50 INPUT "Stop frequency in MHz"; F2$
60 IECOUT SMHU, "RF"+F1$+"MHZ"
70 HOLD 200
80 IECOUT SMHU, "RF"+F2$+"MHZ"
90 INPUT "Repeat"; W$
100 IF W$ = "J" THEN GOTO 60 ELSE GOTO 40
```

3.2.4 Reference Frequency

Allow the SMHU to warm up for approx. 30 minutes.

Connect a calibrated frequency counter (3.1, item 1) to the EXT.REF output (rear panel of instrument) and measure the frequency.

The relative frequency error in the rated temperature range must not exceed

1 E-9 per day of operation + 1 E-7

3.2.5 Harmonic and Subharmonic Spuriae

The harmonic spuriae are checked using a spectrum analyzer (3.1, item 19) connected to the RF output of the SMHU.

Test procedure:

- Set test frequencies from 100 kHz to 4320 MHz with a level of 13 dBm, unmodulated, on the SMHU.
- Check the levels of the harmonic spuriae using the spectrum analyzer. Make sure that the spectrum analyzer is not overdriven.

The level of the harmonic spuriae must never exceed -30 dBc.

The subharmonics are best searched for with the following settings:

SMHU setting	Search frequencies on the analyzer
2161	1080.5 , 3241.5
2719	1359.5 , 4078.5
2722	1361 , 4083
3438	1719 , 5157
3442	1721 , 5163
4320	2160 , 6480

The level of the subharmonic spuriae must not exceed -60 dBc at any point.

3.2.6 Nonharmonic Spuriae

The measurement is carried out using a spectrum analyzer (3.1, item 2) at the RF output, with a level of 10.6 dBm in this case. Since the signal/noise ratios to be measured usually exceed the specifications of the spectrum analyzer, it is necessary to carefully distinguish any spurious signals that are found.

To do this, the level on the SMHU can be reduced by 2.5 dB. If the level of the interference product decreases by more than 2.5 dB, it is an intrinsic spurious product from the analyzer.

The level of the spurious signal should be less than -100 dBc at frequency settings ≤ 1 GHz, less than -94 dBc at frequency settings > 1 GHz, and less than -88 dBc at frequency settings > 2160 MHz.

Recommended setting on spectrum analyzer:

Span 500 Hz, resolution bandwidth 100 Hz, video bandwidth 30 Hz, synchronized reference frequencies of analyzer and DUT.

SMHU settings:

10.6 dBm, FM EXT 0 Hz, AF 0 Hz

The following measurements can be used to determine the instrument-specific mixing products:

- Spurious signals must be looked for at all multiples of 40.5 MHz at each of the following frequency settings on the SMHU:

607.5 MHz / 810 MHz / 1012.5 MHz / 1215 MHz / 1620 MHz / 2025 MHz.

SMHU setting:

15.62 MHz

- Search frequencies:

130 / 260 / 390 / 145.62 / 98.76 / 83.14 / 67.52 / 51.9 / 36.28 / 5.04 MHz

SMHU setting [MHz]	Search frequency [MHz]
1000.625	1001
1001.015625	1000.79063
1009.3125	1009.4025
1015.640625	1015.68563
1024.546875	1024.56187
1027.578125	1027.60312
1031.5625	1030.5625
1022.5625	1023.1425
1015.78125	1015.18125
1009.46875	1010.07875
1004.3125	1004.9925
1031.13054	1030.74826
1022.443181	1023.443181
1009.821428	1010.678568

3.2.7 SSB Phase Noise

To measure the SSB phase noise, the following equipment is required: a second signal generator (3.1, item 5), a phase noise test setup consisting of a mixer with lowpass and preamplifier (3.1, item 6), an oscilloscope (3.1, item 7) and a spectrum analyzer (3.1, item 2).

The two signal generators must be set to the test frequency and synchronized with a 90° shift in phase (phase quadrature). Mixing down to 0 Hz suppresses the RF carrier, and the phase quadrature provides the mixers with a voltage corresponding to the difference in phase between the input signals.

This can be measured by the AF spectrum analyzer and a calculation performed to give SSB phase noise.

Test setup:

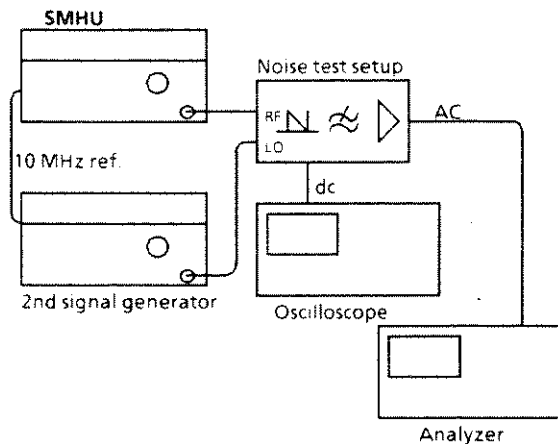

Fig. 3-2

Test procedure:

- Set the levels of the two signal generators according to the specifications of the mixer used.
- To carry out a calibration, set the preamplifier to 0 dB and detune one signal generator by 100 kHz. Measure and record the reference value on the analyzer at 100 kHz.
- Retune the signal generator and produce phase quadrature by switching on special function 23 (phase offset ON) and adjusting the output voltage of the mixer to 0 V using the spinwheel.
- Set the preamplifier to 40 dB and read the noise voltage on the analyzer normalized over a bandwidth of 1 Hz (noise level).
- To obtain the final result, take the reading from the reference level and add 6 dB for the 2nd sideband that was measured as well (correlation) and 40 dB for the gain switch-over to this difference. If the S/N ratio of the second signal generator is not at least 10 dB better than that of the device-under-test, the noise component of the reference generator must also be determined and included in the calculation.

Example:

The reference level is measured as 12 dBm. A noise level of -78 dBm (1 Hz) is found at 20 kHz. The difference is 90 dB plus the correction for the second sideband and the gain switchover giving an S/N ratio of 136 dB or a noise level of -136 dBc (dB referred to the carrier power). If two identical signal generators were used, the result must be reduced by a further 3 dB for the (uncorrelated) noise power of the reference generator. The final result is then -139 dBc.

The following noise levels should be obtained and not exceeded:

Test frequency 1 GHz

Offset from carrier	1	3.2	10	20	100	1000	kHz
Level (typ.)	115	118	130	134	131	142	-dBc

SSB phase noise by 20 kHz from carrier

Carrier frequency	0.1 to 15.625	100	500	1000	2000	4000	MHz
Level (typ.)	147	150	140	134	128	122	-dBc
Level (guar.)	<141	<144	<136	<130	<124	<118	-dBc

3.2.8 Broadband Noise

The broadband noise is measured using the test setup of 3.2.7 (SSB phase noise). The calibration is also the same. To carry out the measurement, detune the signal generators until the frequency difference falls within the stop band of the lowpass (>2 MHz). The spectrum analyzer then shows a 1-MHz section of the wideband power spectrum produced by the two signal generators. This range corresponds to the carrier offset of the difference frequency to the difference frequency minus 1 MHz. The measured power must be halved because of the mirror inversion of the spectrum about the zero line.

Test procedure:

- Carry out the first two steps as described in 3.2.7.
- Detune the deviation frequency (>2 MHz, even more recommended deviation frequency 5 MHz).

- Set the preamplifier to 40 dB and read the noise voltage on the analyzer at a center frequency of approx. 100 kHz, normalized to a bandwidth of 1 Hz (noise level).
- Evaluate by taking the result from the reference level and adding 43 dB for the gain switchover and the reflection band. The measured value is the total noise power of both signal generators. The noise component of the reference transmitter must also be determined and incorporated in the calculation if the S/N ratio of the second signal generator is not at least 10 dB better than that of the device-under-test. A further correction of 3 dB is necessary if the two transmitters are identical.

Recommended test frequencies: 10, 31, 62, 124, 248, 498, 998, 1399, 2160 MHz.

The corrected measured values should be below -140 dBc (1 Hz).

3.2.9 Residual FM

The residual FM of the SMHU cannot be measured using commercially-available demodulators. With the measurement of the SSB phase noise, measurement of the residual FM is no longer required since the former is more sensitive.

3.2.10 Residual AM

Test setup as in 3.2.18.

Test procedure:

- Set various test frequencies, unmodulated, with a level of 0 dBm on the SMHU.
- Read the unweighted residual AM on the modulation analyzer, with a 30-Hz highpass and 20-kHz lowpass with an rms detector.

The residual AM should not exceed 0.01%.

3.2.11 Output Level

Test setup:

Connect power meter (3.1, item 8) to the RF output connector.

Test procedure:

- Set an RF level of 0 dBm, unmodulated, on the SMHU. Measure the level at output frequencies from 100 kHz to 4320 MHz.

The frequency response flatness determined (difference between smallest and largest levels) must not exceed 1 dB.

3.2.12 Calibrated Attenuator

Correct operation of the calibrated attenuator can be checked by comparing it with a precision attenuator using a sensitive test receiver.

Test setup:

Connect a precision attenuator (3.1, item 9) to the RF output of the SMHU and a test receiver (3.1, item 10) to the output of the attenuator using screened RF cables.

Test procedure:

- Set SMHU and test receiver to 100 MHz, attenuator to 120 dB attenuation and SMHU to 13 dBm, unmodulated.
- Read the level on the test receiver and record as the reference value. It should be approx. 0 dB μ V. Select the test bandwidth so that the value can be read exactly.
- Repeat the measurement with the values shown in Table 3-1.

The indication on the test receiver must not deviate from the reference value by more than 1 dB plus the attenuation error of the reference attenuator.

Table 3 - 1

Level on SMHU [dBm]	Attenuation of precision attenuator [dBm]
13	120
10.5	117.5
8	115
3	110
-7	100
-27	80
-47	60
-67	40
-87	20
-107	0

3.2.13 Output Reflection Coefficient

The output reflection coefficient can be checked using a directional coupler (3.1, item 11), a second signal generator (3.1, item 5) and a spectrum analyzer (3.1, item 2).

Test setup:

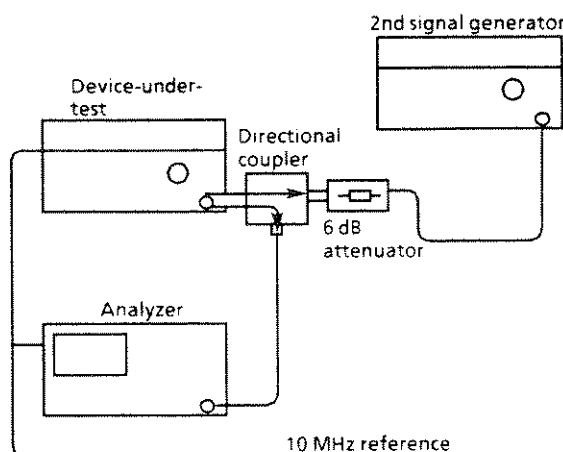

Fig. 3-3

The directional coupler must be screwed directly onto the output connector of the device-under-test, the 6 dB attenuator must be screwed directly onto the directional coupler.

The attenuator is required so that the measurement does not depend on the output reflection coefficient of the second signal generator. In the case of measurements at high output levels (no attenuators or only a few mechanical attenuators), the level of the device-under-test must be reduced by means of special function 1 (transient-free level setting) so that the second signal generator can still deliver the reference level.

Recommended test levels:

11 dBm, special function 1, 6 dBm (no mechanical attenuator)

10 dBm, special function 1, 6 dBm (2.5 dB attenuation)

5 dBm, without special function (5 dB attenuation)

0 dBm, without special function (10 dB attenuation)

etc. in steps of 10 dB up to -70 dBm.

Test procedure:

- Set the test level and test frequency, unmodulated, on the SMHU.
- Set the spectrum analyzer to the test frequency and test level with a 10-kHz resolution and video bandwidth, 0-Hz span, linear scale and sweep time of 30 ms.
- Detune the second signal generator by 100 Hz referred to the test frequency and first set to minimum level, unmodulated.
- Position the line displayed on the spectrum analyzer approximately in the center of the screen by changing the reference level and then read and note the level as the reference level.
- Unscrew the bridge from the SMHU and increase the level on the second signal generator until the reference level is shown again on the analyzer.
- Connect the bridge to the SMHU again. A wavy line is now displayed on the spectrum analyzer which represents the VSWR of the SMHU. The VSWR can be calculated from the maximum and minimum voltages using

$$VSWR = V_{max}/V_{min}$$

Passive measurement of the output reflection coefficient is sufficient at output levels < -10 dBm.

- Set the device-under-test to a frequency highly different from the test frequency, but at the test level.
- Set the second signal generator to the test frequency with a level of 10 dBm.
- To carry out the calibration, unscrew the directional coupler from the device-under-test.

The voltage now measured on the analyzer corresponds to a reflection coefficient of 100 % and must be noted as the reference value.

- To carry out the measurement, screw the directional coupler back onto the output connector of the device-under-test.

The ratio between the voltage now measured on the analyzer and the reference voltage is equal to the reflection coefficient, i.e.

$$|r| = V_{meas}/V_{ref}$$

The voltage standing-wave ratio VSWR can then be calculated:

$$VSWR = (1 + r)/(1 - r)$$

The VSWR must remain below 1.8 or the reflection coefficient below 0.29 at frequencies up to 3 GHz, and the VSWR must remain below 2.5 or the reflection coefficient below 0.43 at frequencies above 3 GHz.

3.2.14 Transient-free Level Settings

The transient-free level settings can be checked at the RF output of the SMHU using a power meter (3.1, item 8).

Preparation:

- Set 100 MHz, unmodulated, with a level of 10 dBm on the SMHU.
- Activate special function 1 (Transient-free Level Settings).

Test procedure:

- Note the level on the power meter as the reference value or set the power meter to 0 dB for relative measurements.
- Reduce the level on the SMHU in steps of 5 dB (most conveniently by programming VAR STEP and using the arrow keys).

The following deviations should be obtained:

At -5 dB	± 0.1 dB
At -10 dB	± 0.2 dB
At -15 dB	± 0.3 dB
At -20 dB	± 0.4 dB

3.2.15 Overvoltage Protection

Test setup:

In order to check the overvoltage protection, connect an adjustable dc voltage source (3.1, item 12) via a 50- Ω resistor or a signal generator (3.1, item 5) with a series-connected power amplifier with a power output of more than 1 Watt (3.1, item 13) to the RF output connector of the SMHU.

Test procedure:

- Set 100 MHz, unmodulated, at a level of -120 dBm on the SMHU.
- Apply the dc voltage via the 50- Ω resistor.

The overvoltage protection circuit must trigger at a voltage >5 V and <10 V and with both polarities.

- Connect the signal generator to the RF output of the SMHU via the power amplifier and apply frequencies between 10 and 4320 MHz.

The overvoltage protection circuit must trigger at an applied RF power of 0.5 to 1 W.

3.2.16 AF Generator

In order to check the AF generator, connect an audio analyzer (3.1, item 14) to the AF connector of the SMHU.

- Set AF 100 kHz on the SMHU and read the actual frequency on the audio analyzer. This must be between 99996 and 100004 Hz.
- Set AF 1 kHz and AF LEV 1000 mV on the SMHU and read the actual value on the audio analyzer. It must be between 989.5 and 1010.5 mV.
- Vary the AF from 10 Hz to 100 kHz on the SMHU and observe the level on the audio analyzer. The frequency response flatness, i.e. the difference between the largest and smallest levels should be <0.4 dB up to 20 kHz and <0.6 dB up to 100 kHz.
- Set AF 1 kHz and AF LEV 500 mV on the SMHU and determine the distortion using the audio analyzer. It should be $<0.1\%$.

- Switch on the fixed-frequency generator using SHIFT FIXED and measure the level and distortion at the two fixed frequencies, limits as above.
- Connect the oscilloscope (3.1, item 7) to the AF output, switch on the synthesizer again using AF INT/ON and check the squarewave and sawtooth waveforms at 1 kHz. The peak value should be the same as with a sinewave, the waveforms should have no overshoots.

3.2.17 Checking Level Monitoring at the External Modulation Inputs

In order to check the monitoring circuits, connect the generator output of the audio analyzer (3.1, item 14) to the external modulation inputs.

Test procedure:

- Select AM EXT AC or FM EXT AC on the SMHU.
- The display EXT LOW should appear for generator levels below $0.98 \pm 0.01 V_{\text{peak}}$ and the display EXT HIGH at levels above $1.02 \pm 0.01 V_{\text{peak}}$, both displays should be off between these values.

3.2.18 AM Modulation Depth

Test setup:

In order to check the modulation characteristics, connect a modulation analyzer (3.1, item 15) to the RF output of the SMHU and an audio analyzer (3.1, item 14) to the AF output of the modulation analyzer.

Connect the generator output of the audio analyzer to the external modulation input connector on the SMHU.

For measurements at carrier frequencies above 1360 MHz, convert the RF output signal of the SMHU to the operating frequency range of the modulation analyzer using a second signal generator (3.1, item 5) and a mixer (3.1, item 16). The second signal generator is operated unmodulated as a local oscillator with a level of 16 dBm and set 10 MHz below the test frequency.

Test procedure:

- Set a level of 4.6 dBm and AM INT with 0.1 to 80% modulation depth at 1 kHz AF (recommended values: 30% and 80%) on the SMHU. Vary the carrier frequency from 100 kHz to 4320 MHz.
- Read off the modulation depth on the modulation analyzer.

The deviation of the measured modulation depth from the set value must not exceed 4% of the display + 1%.

3.2.19 AM Frequency Response

Test setup as in 3.2.18

Test procedure:

- Set a level of 4.6 dBm and AM EXT AC with 80% modulation depth on the SMHU. Vary the carrier frequency from 100 kHz to 4320 MHz.
- Set the generator level of the audio analyzer to 1 V_{peak}.
- Determine the modulation frequency response flatness by varying the AF.

The modulation frequency response flatness (difference between largest and smallest modulation depth) should not exceed 1 dB between 10 Hz and 20 kHz.

3.2.20 AM Distortion

Test setup as in 3.2.18

Test procedure:

- Set a level of 4.6 dBm and AM INT with 60% modulation depth at 1 kHz AF on the SMHU. Vary the carrier frequency from 100 kHz to 4320 MHz.
- Read off the distortion on the audio analyzer.

The distortion must not exceed 2%.

3.2.21 AM DC

Test setup:

Connect an RF analyzer (3.1, item 2) to the RF output of the SMHU and a variable dc voltage source (3.1, item 12) to the external AM input of the SMHU.

Test procedure:

- Set AM EXT dc with 100% modulation depth at a level of 0 dBm and various carrier frequencies on the SMHU.
- Observe the level on the RF analyzer when varying the applied dc voltage.

The level should increase by 6 ± 0.2 dB when varying the dc voltage to +1 V and should drop by at least 30 dB at voltages below -1 V.

3.2.22 Incidental Φ M in AM mode

Test setup as in 3.2.18

Test procedure:

- Set various test frequencies on the SMHU with a level of 0 dBm at AM INT 30% and AF 1 kHz.
- Measure the resulting phase modulation on the modulation analyzer with a 20-kHz low-pass and peak weighting.

The measured spurious modulation must not exceed 0.2 rad at carrier frequencies up to 2000 MHz and 0.4 rad above 2000 MHz.

3.2.23 Digital AM (AM Square)

The dynamic range can be determined using a spectrum analyzer (3.1, item 2) at the RF output of the SMHU.

- Connect a pulse generator (3.1, item 17) to the AM EXT connector and set AM SQUARE 100%.
- Determine the output level of the SMHU at various carrier frequencies with high and low signals applied. The difference should always be >30 dB.
- Connect an oscilloscope (3.1, item 7) to the video output of the analyzer and operate the analyzer in linear mode with a resolution bandwidth and a video bandwidth of 1 MHz, span 0 Hz, as a demodulator at the test frequency.

The rise and fall times measured on the oscilloscope from 10 to 90% of the amplitude must not exceed 2 μ s.

3.2.24 Pulse Modulation

The ON/OFF ratio can be determined using a spectrum analyzer (3.1, item 2) at the RF output connector of the SMHU.

- Connect a pulse generator (3.1, item 17) to the PULSE socket on the rear panel of the SMHU and switch on pulse modulation.
- Determine the output level of the SMHU at various carrier frequencies with high and low signals applied. The difference should always be >80 dB.

To measure the rise time, connect a sampling oscilloscope to the RF output of the SMHU. The oscilloscope should be triggered externally by the pulse generator.

- Set carrier frequencies >125 MHz on the SMHU.
- Set a squarewave pulse sequence with a frequency of approx. 10 MHz, TTL level, on the pulse generator.
- Evaluate the blanked RF signal on the oscilloscope.

The rise time, i.e. the time taken for the signal to rise from 10% to 90% of the RF amplitude, should be <20 ns. The same applies to the fall time, i.e. the time taken for the signal to fall from 90% to 10% of the RF amplitude.

3.2.25 FM Deviation Setting

Test setup as in 3.2.18

Test procedure:

- Set RF 100 MHz with a level of 6 dBm and FM INT with a deviation of 10 Hz to 100 kHz at 1 kHz AF on the SMHU (recommended values: 1/3/10/30 and 100 kHz).
- Read the FM deviation on the modulation analyzer.

The measured deviation must not differ from the set value by more than 3% of the display or 20 Hz.

3.2.26 FM Frequency Response

Test setup as in 3.2.18

Test procedure:

- Set RF 100 MHz, a level of 6 dBm and FM INT with a deviation of 50 kHz on the SMHU.
- Determine the modulation frequency response by varying the AF of the SMHU from 20 Hz to 100 kHz.

The modulation frequency response flatness (difference between largest and smallest modulation depth) should not exceed 0.5 dB.

3.2.27 FM Distortion

Test setup as in 3.2.18

Test procedure:

- Set a level of 6 dBm and FM INT with a deviation of 50 kHz at 1 kHz AF on the SMHU, carrier frequency 100 MHz.
- Read off the distortion on the audio analyzer. The distortion must not exceed 0.2%.
- Reduce the deviation on the SMHU to 25 kHz. Switch on a preemphasis of 50 μ s, also on the demodulator. The distortion must now not exceed 1%.

3.2.28 FM Pre-emphasis

Test setup:

Connect a modulation analyzer (3.1, item 15) to the RF output of the SMHU.

- Set FM INT with a deviation of 25 kHz on the SMHU at RF 100 MHz. Read the deviation on the modulation analyzer at AF 100 Hz and record as the reference value.
- Select a pre-emphasis of 50 μ s on the SMHU and increase the AF to 15 kHz. The deviation now measured should be 122.4 ± 7 kHz, or 179 ± 10 kHz at a preemphasis of 75 μ s.

3.2.29 Incidental AM with FM

Test setup as in 3.2.18

Test procedure:

- Set various test frequencies on the SMHU at a level of 4.6 dBm with FM INT set to 40 kHz and AF 1 kHz.
- Measure the resulting amplitude modulation on the modulation analyzer with a 20-kHz lowpass and peak weighting.

The measured spurious modulation must not exceed 0.1%.

3.2.30 Frequency Deviation with FM

Test setup:

Connect an RF counter (3.1, item 1) to the RF output of the SMHU.

Test procedure:

- Set 100 MHz with a level of 0 dBm and FM EXT AC with a deviation of 0 Hz on the SMHU.
- Observe the change on the frequency counter when switching the FM on and off.

The frequency deviation when FM is switched on must be <10 Hz.

- Set FM EXT dc with a deviation of 100 kHz on the SMHU.

The frequency deviation when FM is switched on must now be <1010 Hz.

3.2.31 FSK Modulation

Test setup:

Connect a pulse generator (3.1, item 17) to the FM EXT input of the SMHU and a modulation analyzer (3.1, item 15) to the RF output. Connect an oscilloscope (3.1, item 7) to the AF output of the modulation analyzer.

- Set a carrier frequency of 500 MHz and FSK with a deviation of 100 kHz on the SMHU. Operate the modulation analyzer with a maximum bandwidth (200-kHz lowpass, 10-Hz highpass).

- Set a squarewave pulse sequence with a repetition frequency of 10 kHz and TTL level on the pulse generator.

The peak deviation displayed on the modulation analyzer should be 100 ± 4 kHz. A squarewave should be displayed on the oscilloscope with a rise time <10 μ s from 10 to 90% of the amplitude.

3.2.32 Φ M Deviation Setting

Test setup as in 3.2.18

Test procedure:

- Set RF 100 MHz with a level of 6 dBm and Φ M INT with a deviation of 0.01 to 10 rad at 1 kHz AF on the SMHU (recommended values 0.1/0.3/1/3/10 rad).
- Read the Φ M deviation on the modulation analyzer.

The measured deviation must not differ from the set value by more than 5% of the display or 0.03 rad.

3.2.33 Φ M Frequency Response

Test setup as in 3.2.18

Test procedure:

- Set a level of 0 dBm and Φ M INT with a deviation of 5 rad on the SMHU. Set the carrier frequency to 100 MHz.
- Determine the modulation frequency response by varying the AF.

The modulation frequency response (difference between largest and smallest modulation depth) should not exceed 1 dB from 10 Hz to 10 kHz.

3.2.34 Φ M Distortion

Test setup as in 3.2.18

Test procedure:

- Set a level of 0 dBm and Φ M INT with a deviation of 5 rad at 1 kHz AF on the SMHU, carrier frequency 100 MHz.
- Read the distortion on the audio analyzer.

The distortion must not exceed 0.5%.

Additions to model SMHU 58:

3.2.35 Harmonic Spuriae

The measurement is performed in accordance with that of the basic instrument described in section 3.2.5; the test frequencies are however restricted to the range of 10 to 1900 MHz. The levels of the harmonic spuriae must not exceed a value of -30 dBc.

3.2.36 Non-Harmonic Spuriae

The measurement is performed in accordance with that of the basic instrument described in section 3.2.6. The following measurements serve to detect device-characteristic spuriae and mixture products. Depending on whether and which coders are fitted, the appropriate measurements for the coders must be performed in addition to those of the basic instrument SMHU58.

RF at SMHU58 [MHz]	Op. mode	Search frequency [MHz]	Spuriae [dBc]
1000	BB-FM ext. SF 315 FM 0Hz	1000 ± 5	< -74
900	"	880	< -74
1900	"	340	typ. < -45
1000	DM: GMSK F: 3 SF 307	1000 ± 4.333	< -74
1000	DM: DECT F: 5 SF 307		< -74
1000	DM: ADC F: 3 SF 307		< -74

3.2.37 SSB Phase Noise

SSB phase noise is tested as described in section 3.2.7 for the basic instrument. As in the operating modes I/Q and GMSK the noise depends just slightly on the set RF frequency, the measurement must be performed only at one RF frequency.

Test procedure:

- Set an RF of 1.9 GHz with a level suitable for the mixer used as well as the operating mode BB-FM ext., FM 0 Hz, SF 315 (PLL broad). If a SMGU or SMHU is used as reference signal generator, the results need not be corrected by 3 dB as these instruments make only very minor contributions to the total noise.

The following noise levels should be measured or should not be exceeded.

Test frequency: 1.9 GHz

Carrier offset	1 kHz	20 kHz	100 kHz
Level	< - 94 dBc	< - 98 dBc	< - 112 dBc

3.2.38 Broadband Noise

When measuring the broadband noise the fact is made use of that in the operating mode I/Q without input signal the RF carrier is reduced by > 50 dB. The broadband noise level can thus be measured directly using a spectrum analyzer.

Test setup:

- Connect the spectrum analyzer to the RF output of the SMHU58 and terminate the I-input and Q-input against 50 Ω .

Test procedure:

- Set an RF of 100 MHz with a level of 0 dBm on the SMHU58. Switch on the operating mode I/Q, the level must fall down to < - 50 dBm. Increase the input sensitivity of the spectrum analyzer to -40 dBm and measure the noise power within a bandwidth of 1 Hz with a carrier offset of 2 MHz using the marker. The characteristic measurement value of < -135 dBm should be obtained.

3.2.39 BB-FM Deviation Accuracy

A modulation analyzer (3.1 item 15) and a frequency divider (3.1 item 20) which reduces the maximum frequency deviation of 50 MHz to such an extent that the modulation range of the deviation meter is not exceeded is required for testing the deviation accuracy as well as the distortion factor. A division factor of 100 is necessary for use of the modulation analyzer according to section 3.1.

Test setup:

- Connect the input of the frequency divider to the RF output of the SMHU 58 and the modulation analyzer to the divider output. Connect the AF generator with an internal resistance of 50 ohm (3.1 item 21) to the BB-FM ext. input at the rear panel.

Test procedure:

- Set an RF of 1000 MHz with a level of 0 dBm and BB-FM int. with an AF of 1 kHz on the SMHU. With a division factor of 100 the modulation analyzer is supposed to indicate an RF of 10 MHz. Check the deviation accuracy with the following settings. The deviation error read off on the modulation analyzer must not exceed 5 %.

BB-FM deviation on SMHU58 [MHz]	Deviation display on modulation analyzer·division factor [MHz]
25	23.75...26.25
10	9.5...10.5
8	7.6...8.4
6	5.7...6.3
4	3.8...4.2
1	0.95...1.05
0.2	0.19...0.21
0.05	0.0475...0.0525

Switch off the internal AF generator with AF 0 Hz. Switch over to operating mode BB-FM ext.AC and set the level of the external AF generator to 1 V_p into 50 ohm. The jumper bridge XB 60 must be plugged onto the position 2-3 (R_i = 50 ohm) during this procedure. Test the deviation accuracy again as described with BB-FM int.

3.2.40 BB-FM Distortion

Test setup as in section 3.2.40; in addition an audio analyzer for distortion measurement is connected to the AF output of the modulation analyzer.

Test procedure:

- Set an RF of 1000 MHz with a level of 0dBm and BB-FM int. with an AF of 1 kHz on the SMHU. Read off the distortion on the audio analyzer in the case of the following deviation settings (recommended values 0.2/1/ 2/ 4/ 8/ 10/ 25 MHz). A value of 5 % must not be exceeded.

3.2.41 Residual FM with BB-FM / I/Q

Test setup:

- Connect the modulation analyzer to the RF output of the SMHU58.

Test procedure:

- Set an RF of 140 MHz with a level of 0 dBm and BB-FM ext. on the SMHU58. Terminate the modulation input at the rear panel with a 50-ohm resistor. Read off the residual FM with the corresponding weighting bandwidth and rms value rectifier in the case of the following settings. The limit values must not be exceeded.

BB-FM deviation on the SMHU58 [MHz]	Residual FM on the modulation analyzer	
	Weighting bandwidth CCITT [Hz _{rms}]	0.03-20 kHz [Hz _{rms}]
0.2	< 20	< 50
1	< 40	< 150
5	< 100	< 400
25	< 400	< 1600
50	< 400	< 1600

Set the operating mode BB-AM at the SMHU58. Residual FM must not exceed a value of 40 Hz_{rms} from 8 (or 0.03) to 20 kHz according to CCITT.

3.2.42 BB-FM Frequency Response

Measuring the BB-FM frequency response requires a frequency discriminator according to figure 3-4 for broadband demodulation and a generator as modulation source (3.1 item 21). Furthermore a vector voltmeter (3.1 item 22) for determination of the frequency response by defining the ratio of modulating signal to demodulated signal is necessary. Frequency response of the generator can thus be omitted during the measurement.

The FM discriminator consists of a power splitter, a delay line (delay time < 6 ns or cable length < 1.2 m with a shortening factor of 0.66), with which frequency changes are transferred into phase changes, as well as of a mixer used as phase discriminator.

Test setup:

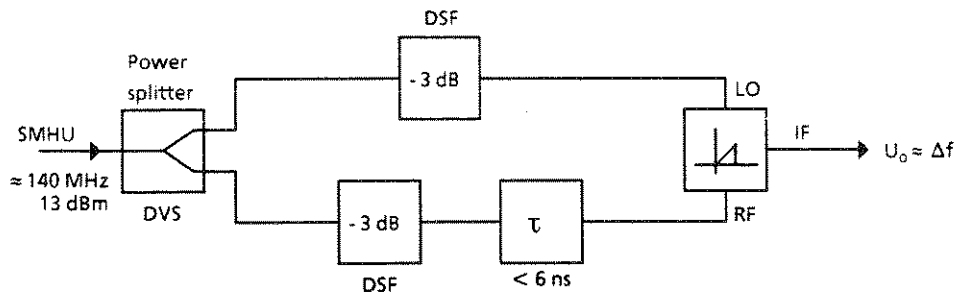

Fig. 3-4 Circuit diagram frequency discriminator

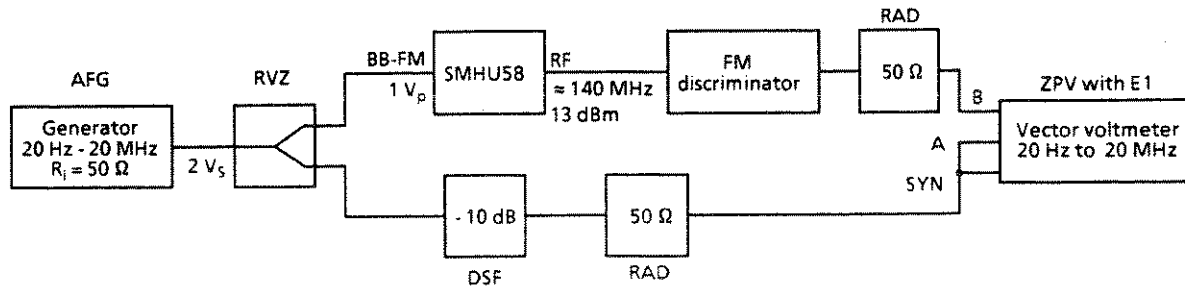

Fig. 3-5 Circuit diagram of BB-FM frequency response measurement

Test procedure:

- Set an RF of 140 MHz with a level of 0 dBm on the SMHU 58. Connect an oscilloscope (3.1 item 7) to the output of the frequency discriminator, set it to an output voltage of 0 V (phase quadrature) using the RF frequency of the SMHU 58 (step size 10 kHz). Remove the oscilloscope from the test setup and connect the B channel of the vector voltmeter to the output of the FM discriminator; set BB-FM ext. with a deviation of 25 MHz on the SMHU58 and $2 V_p$ into 50 ohm with a frequency of 1 kHz on the modulation generator. Set the vector voltmeter to the operating mode B/A and LOG.REF. and carry out the reference calibration using the knob PARAM.CAL. Display of the ratio B/A should now be 0.00 dB. Vary the frequency from 20 Hz to 20 MHz (recommended values 20/ 50/ 200 Hz/ 1/ 10/ 100 kHz/ 1/ 5/ 10/ 15/ 20 MHz) on the modulation generator, the modulation frequency response (difference between highest and lowest B/A value) should not exceed 3 dB. Repeat the same measurement, however use the deviation settings 5, 1 and 0.2 MHz on the SMHU58. Switch on the special function SF 315 (PLL broad) with a deviation of 25 MHz on the SMHU58, perform the reference calibration on the vector voltmeter at a modulation frequency of 500 kHz. Vary the modulation frequency from 100 kHz to 20 MHz (recommended values 100/ 200/ 500 kHz/ 1/ 5/ 10/ 15/ 20 MHz), frequency response must again not exceed 3 dB.

3.2.43 Level Accuracy with BB-AM

Test setup:

- Connect the power meter (3.1 item 8) to the RF output socket.

Test procedure:

- Set a level of 0 dBm without modulation at an RF of 100 MHz on the SMHU 58. Switch on the operating mode BB-AM using the special function SF 303. The difference in the output levels of both operating modes must not exceed 0.5 dB.

3.2.44 BB-AM Modulation Depth

Test setup:

- To test the modulation characteristics connect a modulation analyzer to the RF output of the SMHU58 and an audio analyzer to the AF output of the modulation analyzer. Connect a modulation generator with an internal resistance of 50 ohm (3.1 item 20) to the BB-AM input located at the rear panel of the SMHU 58.

Test procedure:

- Set an RF of 140 MHz with a level of 7 dBm on the SMHU58 and switch on the operating mode BB-AM using the special function SF 303. Vary the level from 0 V_p to 1 V_p into 50 ohm (recommended values 0.1/ 0.3/ 0.8 V_p) with a frequency of 1 kHz on the modulation generator while reading off the modulation depth on the modulation analyzer.

Deviation from the nominal value $(U_p/1 V) * 100 \% (10/ 30/ 80 \%)$ must not exceed 5 %.

3.2.45 BB-AM Distortion

Test setup as described in section 3.2.25.

Test procedure:

- Set an RF of 140 MHz with a level of 7 dBm on the SMHU58 and switch on the operating mode BB-AM using special function SF 303. Set the level of the modulation generator to 0.6 V_p into 50 ohm with a frequency of 1 kHz. Read off the distortion on the audio analyzer; it must not exceed a value of 0.5 %.

3.2.46 BB-AM Frequency Response

Measure the level of the modulation sidebands and thus the modulation depth in the specified modulation frequency range using a spectrum analyzer.

Test setup:

- Connect a spectrum analyzer (3.1 item 2) to the RF output of the SMHU58 and a signal generator (3.1 item 5) used as a modulation generator to the input BB-AM at the rear panel of the SMHU58.

Test procedure:

- Set an RF of 140 MHz with a level of 7 dBm on the SMHU and select the operating mode BB-AM using special function SF 303. Set the level of the modulation generator to 5.56 dBm (this corresponds to a modulation depth of 60 % or an offset to the side bands of 10.5 dB). Set the spectrum analyzer to a start frequency of 140 MHz and a stop frequency of 190 MHz with a REF.LEVEL of 7 dBm and a sensitivity of 2 dB/division. Switch the display mode of the sweep to the operating mode MAX.HOLD, then vary the modulation frequency continuously from 100 kHz to 50 MHz. Read off the frequency response of the upper modulation sideband, i.e. the difference between minimal and maximal level, on the spectrum analyzer. A value of 3 dB must not be exceeded.

3.2.47 Testing the Carrier Leakage with I/Q Modulation

The carrier leakage is checked with an input voltage of 0 V at the I-input and Q-input using a spectrum analyzer.

Test setup:

- Connect a spectrum analyzer (3.1 item 2) to the RF output of the SMHU58; terminate the I- and Q- inputs at the rear panel with 50 ohm.

Test procedure:

- The SMHU58 must have warmed up already for an hour before this measurement can be performed. Calibrate the I/Q modulator using special function SF 320. Subsequently set a level of 0 dBm with an RF of 140 MHz and the operating mode I/Q. The level indicated on the spectrum analyzer at 140 MHz must be ≤ -50 dBm.

3.2.48 Testing the Vector DC Accuracy with I/Q Modulation

Use a vector analyzer for measuring the static vector accuracy. The I/Q modulated carrier is the A-signal, the coherent carrier is the R-signal and the ratio A/R is then measured. The I/Q control voltages are generated by a dual power supply with a voltage divider connected in outgoing circuit. The ratio of useful voltage to offset voltage is thus improved and an internal resistance of 50 ohm is generated.

Test setup:

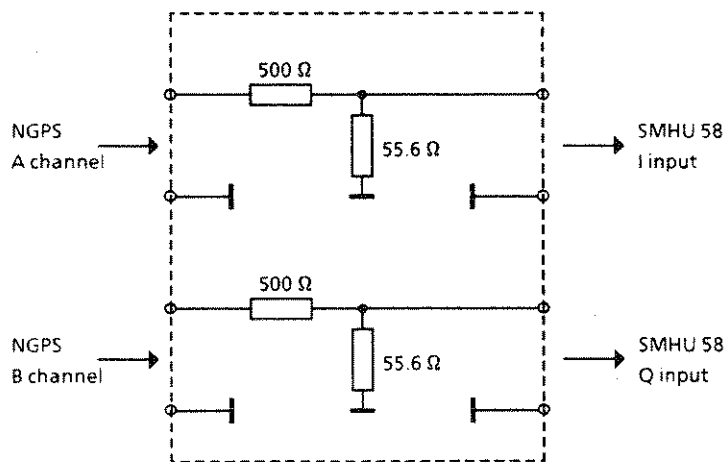

Fig. 3-6 Voltage divider for I/Q inputs

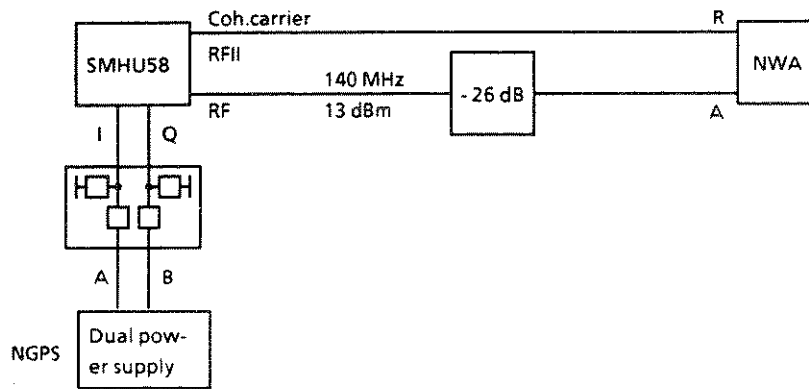

Fig. 3-7 Test setup for checking the vector DC accuracy

Test procedure:

- The SMHU58 must have warmed up for one hour before carrying out this measurement. Calibrate the I/Q modulator using special function SF 320. Set a level of 13 dBm with an RF of 140 MHz and select the operating mode I/Q on the SMHU58. Set the voltage at the dual power supply to 10 V emf for the I-channel. This setting is the reference for the accuracy measurement. More precise results can be achieved by determining the reference by averaging the measurement results of the four input signals taking into account all four axes. For this purpose a processor-controlled weighting is however necessary. Select the operating mode A/R (in the case of the HP8753B key sequence: Meas > INPUT PORTS > A/R), external source (System > INSTRUMENT MODE > EXT. SOURCE AUTO) and display mode POLAR (Format > POLAR) on the NWA. Set the read format of the marker to Re/Im MKR (Marker > MARKER MODE MENU > POLAR MKR MENU > Re/Im MKR). Then perform the reference calibration on the NWA (Cal > CALIBRATE MENU > RESPONSE > THRU > DONE RESPONSE). The marker should now indicate the values Re = 1.000 ± 0.001 and Im = ± 0.001 (full modulation on the I-axis).

Check the static vector accuracy at the following voltage settings, the limit values specified must not be exceeded.

Voltage at power supply [Volt]		Marker display on network analyzer	
I	Q	Re	Im
+ 10	0	+ 0.999 to + 1.001	- 0.001 to + 0.001
+ 5	0	+ 0.485 to + 0.515	- 0.015 to + 0.015
+ 1	0	+ 0.085 to + 0.115	- 0.015 to + 0.015
0	+ 10	- 0.015 to + 0.015	+ 0.985 to + 1.015
0	+ 5	- 0.015 to + 0.015	+ 0.485 to + 0.515
0	+ 1	- 0.015 to + 0.015	+ 0.085 to + 0.115
+ 7.071	+ 7.071	+ 0.692 to + 0.722	+ 0.692 to + 0.722
- 7.071	+ 7.071	- 0.692 to - 0.722	+ 0.692 to + 0.722
- 10	0	- 0.985 to - 1.015	- 0.015 to + 0.015
- 7.071	- 7.071	- 0.692 to - 0.722	- 0.692 to - 0.722
0	- 10	- 0.015 to + 0.015	- 0.985 to - 1.015
- 7.071	+ 7.071	- 0.692 to - 0.722	+ 0.692 to + 0.722
+ 3.536	+ 3.536	+ 0.339 to + 0.369	+ 0.339 to + 0.369
- 3.536	+ 3.536	- 0.339 to - 0.369	+ 0.339 to + 0.369
- 3.536	- 3.536	- 0.339 to - 0.369	- 0.339 to - 0.369
+ 3.536	- 3.536	+ 0.339 to + 0.369	- 0.339 to - 0.369

3.2.49 Testing the Modulation Bandwidth with I/Q Modulation

If only one channel is modulated in the operating mode I/Q the output signal of the signal generator SMHU58 is an amplitude modulation with suppressed carrier, the power of which is directly proportional to the modulation power in the I-channel or Q-channel plus the frequency response error. The modulation frequency response is thus determined by power measurement of the modulated RF signal.

Test setup:

- Connect an RF power meter (3.1 item 8) to the RF output socket and a signal generator (3.1 item 5) to the I-input at the rear panel.

Test procedure:

- Prior to the measurement determine the frequency response of the signal generator at the I-input in the range of 0.1 to 200 MHz using the RF power meter; the correction values must be appropriately considered in the measurement.
Set an RF of 1 GHz with a level of 0 dBm on the SMHU58 and select the operating mode I/Q. Reset every vector offset using special function SF 302. Set a level of 4 dBm on the modulation generator. Vary the modulation frequency from 0.1 to 200 MHz (recommended values 0.1/ 1/ 10/ 50/ 100/ 150/ 200 MHz). The frequency response, i.e. the difference between highest and lowest power display must not exceed 3 dB.

3.2.50 Testing the VSWR of the Modulation Inputs I and Q

Calibrate the NWA using a test cable (span 1 to 200 MHz, S11, Cal S11 1port, 3-working standard); then select the measurement mode SWR. Connect the test cable to the I-input at the rear panel of the SMHU58 and switch on the operating mode I/Q. VSWR must be up to 200 MHz < 1.4. Repeat the measurement for the Q-channel.

3.2.51 Testing the I/Q Vector Imbalance

Test procedure as well as test setup correspond to those described in section 3.2.48.

Test procedure:

- Set a level of 0 dBm with an RF of 140 MHz on the SMHU58 and select the operating mode I/Q. Set a voltage of 10 V emf for the I-channel and 0 V for the Q-channel on the dual power supply unit. The operating mode of the NWA corresponds to that of section 3.2.48, the read format of the marker is LIN MAG (Marker > MARKER MODE MENU > POLAR MKR MENU > LIN MAG). Then carry out the reference calibration. The value display must be 1 ± 0.001 . Switch on vector imbalance using special function SF 301.
Vary the I/Q imbalance from -12% to +12% (preferred values $\pm 12 / \pm 5 / \pm 2 / \pm 0.2$ %); the error of the value display should be < 0.3 % for values below 5 % and < 0.5 % for values over 5 %. Reset the I/Q imbalance to 0 %; set the voltage for the I-channel to 0 V on the dual power supply unit. Vary the carrier leakage from 0 to 50 %, the error of the carrier leakage should not exceed 3 % of the value plus 0.3 %. Reset the carrier leakage to 0 %, set the voltage for the Q-channel to 10 V on the dual power supply unit. Perform a further reference calibration on the NWA. Vary the quadrature offset from -9.9° to +9.9° (preferred values $\pm 9.9 / \pm 5 / \pm 2 / \pm 0.5 / \pm 0.1$ °); the error should be < 0.2° for values lower than 3° and for values higher than 3° < 0.5°. Set the voltage for both channels to 0 V on the dual power supply unit. Vary the functions I/Q imbalance and quadrature offset over the entire setting range, the carrier leakage displayed should be lower than 0.3 %.

Only with B2 Option GMSK Coder fitted:

3.2.52 Testing the Data Rate with GMSK

The pulling range of the crystal oscillator for the internal clock generation of the GMSK coder is tested.

Test setup:

- Connect the clock generator (3.1 item 31) to the CLOCK/BB-AM socket at the rear panel.

Test procedure:

- Switch on the operating mode DM (GMSK), SF 306, SF 308 (PRBS off) on the SMHU58. Select the control voltage PLL coder timing using SF 174. Set the frequency 270.833 kHz on the clock generator. The control voltage is supposed to be in the range of - 6 to - 9 V. Subsequently set the frequencies 270.819 and 270.847 kHz. The error message "Err. 49" must not be displayed on the SMHU58, the control voltage must be within the range of - 2 to - 12 V.

3.2.53 Testing the Modulation Phase Error with GMSK

To test the phase error switch on the filter 15, with which the coder generates I/Q signals for a constant frequency offset of $f_{\text{bit}}/4 = 67.7$ kHz, i.e. the I/Q vector moves in a circle with a rotation frequency of 67.7 kHz. With an ideal I/Q modulator and coder only the frequency $f_{\text{RF}} + 67.7$ kHz occurs in the output spectrum. Each error produces additional spectral lines which correspond to residual ΦM and residual AM and can be measured using a modulation analyzer.

As the Gaussian filtering is generated purely digitally and the influence of the aliasing filters is negligible, further tests are not required.

Test setup:

- Connect the modulation analyzer (3.1 item 32) to the RF output of the SMHU58.

Test procedure:

- Set an RF of 140 MHz with a level of 0 dBm on the SMHU58. Switch on the operating mode DM, F 15, SF 307 (PRBS on). Select the test mode ΦM , weighting bandwidth 10 Hz to 300 kHz on the modulation analyzer. The residual ΦM displayed must be lower than 1°_{rms} and 3°_{p} .

3.2.54 Testing the Spectrum with GMSK Modulation

The RF spectrum with GMSK modulation and $B \times T = 0.3$ is tested using a spectrum analyzer.

Test setup:

- Connect the spectrum analyzer to the RF output of the SMHU58.

Test procedure:

- Set 140 MHz with a level of 13 dBm on the SMHU58. Switch on the operating mode DM, F 3, SF 307 (PRBS on). Settings on the spectrum analyzer: Start 140 MHz, Stop 140.677 MHz, Res.Bw. 10 kHz, Vid.Bw. 10 Hz, Mode Lo Dist. Set the marker to 140 MHz, measure the level with the carrier offsets specified using the delta marker function.

Δf / kHz	ΔP / dB
50	-2.9 ± 0.3
100	-9.5 ± 0.1
150	-24 ± 2
220	-38.5 ± 3
300	-55 ± 3

3.2.55 Testing the Data Rate with DECT

The pulling range of the crystal oscillator for the internal clock generation of the DECT coder is tested.

Test setup:

- Connect the clock generator (3.1 item 31) to the CLOCK/BB-AM socket at the rear panel.

Test procedure:

- Switch on the operating mode DM (DECT), SF 306, SF 308 (PRBS off) on the SMHU58. Select the control voltage PLL coder timing using SF 174. Set the frequency 1152 kHz on the clock generator. The control voltage is supposed to be in the range of - 6 to - 9 V. Subsequently set the frequencies 1152.058 and 1151.942 kHz. The error message "Err. 49" must not be displayed on the SMHU58, the control voltage must be within the range of - 1.5 to - 11.7 V.

3.2.56 Testing the Modulation Frequency Error with DECT

To test the frequency error switch on the filter 15, with which the coder generates I/Q signals for a constant frequency offset of $f_{\text{bit}}/4 = 288$ kHz, i.e. the I/Q vector moves in a circle with a rotation frequency of 288 kHz. With an ideal I/Q modulator and coder only the frequency $f_{\text{RF}} + 288$ kHz occurs in the output spectrum. Each error produces additional spectral lines which correspond to residual ΦM and residual AM and can be measured using a modulation analyzer.

As the Gaussian filtering is generated purely digitally and the influence of the aliasing filters is negligible, further tests are not required.

Test setup:

- Connect the FM demodulator (cf. 3.2.42) with weighting lowpass filter and AC voltmeter (3.1 item 33, URE3 with lowpass 1 MHz) to the RF output of the SMHU58.

Test procedure:

- Set an RF of 140 MHz with a level of 0 dBm on the SMHU58. Set the RF of the SMHU58 using an oscilloscope such that phase quadrature is obtained at the mixer (cf. 3.2.42). Calibrate the frequency discriminator using a defined frequency offset. Switch on the operating mode DM, F 15, SF 307 (PRBS on). The residual FM measured must be less than 12 kHz.

3.2.57 Testing the Spectrum with DECT Modulation

The RF spectrum with DECT modulation and $B \times T = 0.5$ is tested using a spectrum analyzer.

Test setup:

- Connect the spectrum analyzer to the RF output of the SMHU58.

Test procedure:

- Set 140 MHz with a level of 13 dBm on the SMHU58. Switch on the operating mode DM, F 5, SF 307 (PRBS on).

Settings on the spectrum analyzer: Start 140 MHz, Stop 142.880 MHz, Res.Bw. 30 kHz, Vid.Bw. 30 Hz, Mode Lo Dist. Set the marker to 140 MHz, measure the level with the carrier offsets specified using the delta marker function.

df / kHz	dP / dB
200	-1.7 ± 0.3
400	-5.7 ± 0.5
700	-20.5 ± 2
1000	-30.3 ± 3
1500	-56 ± 3

3.2.58 Testing the Data Rate with ADC/JDC

The pulling range of the crystal oscillator for the internal clock generation of the ADC coder with ADC and JDC bit rate is tested.

Test setup:

- Connect the clock generator (3.1 item 31) to the CLOCK/BB-AM socket at the rear panel.

Test procedure:

- Switch on the operating mode DM (ADC), SF 306, SF 308 (PRBS off) on the SMHU58. Select the control voltage PLL coder timing using SF 174. Set the frequency to 48.6 kHz on the clock generator. The control voltage is supposed to be in the range of - 6 to - 9 V. Subsequently set the frequencies 48.6024 kHz and 48.5976 kHz. The error message "Err. 49" must not be displayed on the SMHU58, the control voltage must be within the range of - 2 to - 12 V.
Switch over to JDC bit rate using special function SF323. Set the frequency to 42 kHz on the clock generator. The control voltage is supposed to be in the range of -6 to -9 V. Set the frequencies 42.0021 kHz and 41.9979 kHz. The error message "Err. 49" must not be displayed on the SMHU58, the control voltage must be within the range of - 1.5 to - 11.7 V.

3.2.59 Testing the Modulation Error with ADC

To test the vector error feed in the data sequence 0000... with which the coder generates I/Q signals for a constant frequency offset of $f_{\text{bit}}/16 = 3.0375$ kHz, i.e. the I/Q vector moves in a circle with a rotation frequency of 3.0375 kHz. With an ideal I/Q modulator and coder only the frequency $f_{\text{RF}} + 3.0375$ kHz occurs in the output spectrum. Each error produces additional spectral lines which correspond to residual ΦM and residual AM and can be measured using a modulation analyzer. As the cos filtering is generated purely digitally and the influence of the aliasing filters is negligible, further tests are not required.

Test setup:

- Connect the modulation analyzer (3.1 item 32) to the RF output of the SMHU58.

Test procedure:

- Set an RF of 140 MHz with a level of 0 dBm on the SMHU58. Switch on the operating mode DM, F3, SF 308 (PRBS off). Measure the residual ΦM and residual AM in the weighting bandwidth of 30 Hz to 20 kHz using the modulation analyzer (detector: $\text{RMS} \cdot \sqrt{2}$).
- AM: $< 1.5 \%_s$
- ΦM : $< 0.015 \text{ Rad}_p$

3.2.60 Testing the Spectrum with ADC Modulation

The RF spectrum with ADC modulation with filter 3 (ADC filtering) is tested using a spectrum analyzer.

Test setup:

- Connect the spectrum analyzer to the RF output of the SMHU58.

Test procedure:

- Set 140 MHz with a level of 10 dBm on the SMHU58. Switch on the operating mode DM, F 3, SF 307 (PRBS on). Settings on the spectrum analyzer: Start 140 MHz, Stop 140.025 MHz, Res.Bw. 500 Hz, Vid.Bw. 1 Hz, Mode Lo Dist.
Set the marker to 140 MHz, measure the level in the carrier offsets specified using the delta marker function.

ADC		JDC, SF 323, F 6	
df / KHz	dP / dB	df / KHz	dP / dB
7	0 ± 0.3	5.3	0 ± 0.3
10.7	-1.2 ± 0.5	8.8	-1.2 ± 0.5
12.2	-3 ± 0.7	10.5	-3.4 ± 0.7
13.6	-6.1 ± 1	12.2	-6.2 ± 1
15.6	-16 ± 3	14.3	-13.6 ± 2
17	< -20	15.8	< -20
19	< -40	18	< -40

3.2.61 Testing the Data Rate with CT

The pulling range of the crystal oscillator for the internal clock generation of the CT coder is tested.

Test setup:

- Connect the clock generator (3.1 item 31) to the CLOCK/BB-AM socket at the rear panel.

Test procedure:

- Switch on the operating mode DM (CT), SF 308 (PRBS off) on the SMHU58. Select the control voltage PLL coder timing using SF 174. Set the frequency to 384 kHz on the clock generator. The control voltage is supposed to be in the range of - 6 to - 9 V. Subsequently set the frequencies 384.02 kHz and 383.98 kHz. The error message "Err. 49" must not be displayed on the SMHU58, the control voltage must be within the range of - 1.5 to - 11.7 V. Switch over to symbol timing using special function SF321. Set the frequency to 192 kHz on the clock generator. The error message "Err. 49" must not be displayed, the control voltage must be within the range of - 6 to - 9 V.

3.2.62 Testing the Modulation Error with CT

To test the vector error feed in the data sequence 0000... with which the coder generates I/Q signals for a constant frequency offset of $f_{\text{bit}}/16 = 24$ kHz, i.e. the I/Q vector moves in a circle with a rotation frequency of 24 kHz. With an ideal I/Q modulator and coder only the frequency $f_{\text{RF}} + 24$ kHz occurs in the output spectrum. Each error produces additional spectral lines which correspond to residual ΦM and residual AM and can be measured using a modulation analyzer.

As the cos filtering is generated purely digitally and the influence of the aliasing filters is negligible, further tests are not required.

Test setup:

- Connect the modulation analyzer (3.1 item 32) to the RF output of the SMHU58.

Test procedure:

- Set an RF of 140 MHz with a level of 0 dBm on the SMHU58. Switch on the operating mode DM, F2, SF 308 (PRBS off). Measure the residual ΦM and residual AM in the weighting bandwidth of 30 Hz to 200 kHz using the modulation analyzer (detector: $\text{RMS} \cdot \sqrt{2}$).
- AM: $< 1.5 \%_s$
- ΦM : $< 0.015 \text{ Rad}_p$

3.2.63 Testing the Spectrum with CT Modulation

The RF spectrum with CT modulation with filter 2 (CT filtering) is tested using a spectrum analyzer.

Test setup:

- Connect the spectrum analyzer to the RF output of the SMHU58.

Test procedure:

- Set 140 MHz with a level of 13 dBm on the SMHU58. Switch on the operating mode DM, F 2, SF 307 (PRBS on). Settings on the spectrum analyzer: Start 140 MHz, Stop 140.2 MHz, Res.Bw. 3 kHz, Vid.Bw. 3 Hz, Mode Lo Dist.

Set the marker to 140 MHz, measure the level in the carrier offsets specified using the delta marker function.

df / KHz	dP / dB
48	0 ± 0.3
80	-1.2 ± 0.5
96	-3 ± 0.7
110	-6.1 ± 1
131	-13 ± 1.5
144	< -18
165	< -40

3.3 Performance Test Report

Rohde & Schwarz

Date _____

SIGNAL GENERATOR SMHU

Name _____

Order No. 835.8011.52 / 56 / 58

Serial No.

Item No.	Characteristic	Measurement in section	MIN	ACTUAL	MAX	Unit
	Model 52 / 56 / 58					
1	Displays and keyboard	3.2.1	—		—	—
2	Frequency setting	3.2.2	—			
3	Settling time	3.2.3	—		10	ms
4	Reference frequency	3.2.4	—		—	
5	Harmonic and subharmonic spurious	3.2.5				
	Harmonics		—		-30	dBc
	Subharmonics	—		-60	dBc	
6	Nonharmonic spurious	3.2.6				
	RF > 2.16 GHz		—		-88	dBc
	RF > 1 GHz		—		-94	dBc
	RF ≤ 1 GHz	—		-100	dBc	
7	SSB phase noise	3.2.7				
	Offset 20 kHz RF = 15 MHz		—		-141	dBc(1 Hz)
	Offset 20 kHz RF = 100 MHz		—		-144	dBc(1 Hz)
	Offset 20 kHz RF = 500 MHz		—		-136	dBc(1 Hz)
	Offset 20 kHz RF = 1000 MHz		—		-130	dBc(1 Hz)
	Offset 20 kHz RF = 2000 MHz		—		-124	dBc(1 Hz)
	Offset 20 kHz RF = 4000 MHz	—		-118	dBc(1 Hz)	
8	Broadband noise	3.2.8	—		-140	dBc(1 Hz)
9	Residual AM	3.2.10	—		0.01	%
10	Output level, frequency response	3.2.11	—		1	dB
11	Calibrated-attenuator error	3.2.12	—		1	dB
12	Output reflection coefficient	3.2.13				
	Test level > 0 dBm		—		1.8	(VSWR)
	Test level ≤ 0 dBm	—		1.5	(VSWR)	
13	Transient-free level settings	3.2.14				
	-5 dB		-5.1		-4.9	dB
	-10 dB		-10.2		-9.8	dB
	-15 dB		-15.3		-14.7	dB
	-20 dB	-20.4		-19.6	dB	

Item No.	Characteristic	Measurement in section	MIN	ACTUAL	MAX	Unit
14	Overvoltage protection dc voltage RF supply	3.2.15	5 0.5		10 1	V W
15	AF generator Frequency 100 kHz Level at 1 kHz, 1 V Frequency response up to 20 kHz up to 100 kHz Distortion at 1 kHz	3.2.16	99.996 989.5 — — —		100.004 1010.5 0.4 0.6 0.1	kHz mV dB dB %
16	Level monitoring	3.2.17	—		—	
17	AM modulation depth 80 % 30 %	3.2.18	76 28		84.2 32.2	% %
18	AM frequency response 10 Hz to 20 kHz	3.2.19	—		1	dB
19	AM distortion	3.2.20	—		2	%
20	AM DC At +1 V At -1.1 V	3.2.21	5.8 —		6.2 -30	dB dB
21	Incidental Φ M with AM Up to 2000 MHz Above 2000 MHz	3.2.22	— —		0.2 0.4	rad rad
22	Digital AM Dynamic range Dynamic r. 1800 - 2160 MHz > 1800, > 2160 MHz Rise/fall time	3.2.23	30 —		— 2	dB μ s
23	Pulse modulation ON/OFF ratio Rise/fall time	3.2.24	80 —		— 20	dB ns
24	FM deviation error at 1 kHz at 3 kHz at 10 kHz at 30 kHz at 100 kHz	3.2.25	0.97 2.91 9.70 29.1 97.0		1.03 3.09 10.3 30.9 103	kHz kHz kHz kHz kHz
25	FM frequency response 20 Hz to 100 kHz	3.2.26	—		0.5	dB

Item	Characteristic	Measurement in section	Min.	Actual value	Max.	Unit
26	FM distortion without pre-emphasis with pre emphasis	3.2.27	— —		0.2 1	% %
27	FM pre-emphasis 50 μ s 75 μ s	3.2.28	115.4 169		129.4 189	kHz kHz
28	Incidental AM with FM	3.2.29	—		0.1	%
29	Frequency deviation with FM ac dc 100 kHz	3.2.30	— —		10 1010	Hz Hz
30	FSK modulation Deviation Rise/fall time	3.2.31	96 —		104 10	kHz μ s
31	Φ M deviation error with 0.1 rad with 0.3 rad with 1.0 rad with 3.0 rad with 10 rad	3.2.32	0.094 0.284 0.95 2.85 9.50		0.106 0.316 1.05 3.15 10.5	rad rad rad rad rad
32	Φ M frequency response	3.2.33	—		1	dB
33	Φ M distortion	3.2.34	—		0.5	%
	Model 58					
34	Harmonic spurious	3.2.35			-30	dBc
35	Non-harmonic spurious RF 10-250MHz RF 845-1005MHz RF 1650-1900MHz RF 10-1900MHz				-74 -74 -74	dBc dBc dBc dBc
36	SSB phase noise Offset 1kHz Offset 20kHz Offset 100kHz	3.2.37			-94 -98 -112	dBc(1Hz) dBc(1Hz) dBc(1Hz)
37	Broadband noise	3.2.38				dBc(1Hz)
38	Residual FM, rms I/Q, GMSK, BB-AM BB-FM, deviation <0.4MHz BB-FM, 0.4 < deviation <2MHz BB-FM, 2 < deviation <10MHz BB-FM, deviation >10MHz	3.2.41			8 40 20 50 40 100 100 500 400 2000	Hz _{rms} , CCITT Hz _{rms} , other Hz _{rms} , CCITT Hz _{rms} , other Hz _{rms} , CCITT Hz _{rms} , other Hz _{rms} , CCITT Hz _{rms} , other Hz _{rms} , CCITT Hz _{rms} , other

Item No.	Characteristic	Measurement in section	MIN	ACTUAL	MAX	Unit
39	Level RF2, coh. 10 MHz to 1,9 GHz min. level max. level	3.2.11				dBm dBm
40	AM modulation depth with BB-FM, GMSK m = 80% m = 30%	3.2.18	76 28		84.2 32.2	% %
41	AM frequency response with BB-FM, GMSK 10 Hz to 20 kHz	3.2.19	—		1	dB
42	AM distortion with BB-FM, GMSK	3.2.20			2	%
43	Residual Φ M with AM with BB-FM, GMSK	3.2.22			0.2	rad
44	Digital AM with BB-FM, GMSK Dynamic range Rise/fall time	3.2.23				dB μ s
45	Pulse modulation ON/OFF ratio Rise/fall time	3.2.24	80		20	dB ns
46	BB-FM deviation error with deviation 200kHz with deviation 1MHz with deviation 5MHz with deviation 25MHz	3.2.39	190 0.95 4.75 23.75		210 1.05 5.25 26.25	kHz MHz MHz MHz
47	BB-FM distortion with deviation 25MHz	3.2.40			0.5	%
48	BB-FM frequency response with deviation 25MHz fmod = 20Hz to 20MHz	3.2.42			3	dB
49	BB-AM level error	3.2.43			0.5	dB
50	BB-AM modulation depth m = 80%	3.2.44	86.8		83.2	%
51	BB-AM distortion	3.2.45			0.5	%
52	Residual Φ M with BB-AM	3.2.22				rad
53	BB-AM frequency response DC to 50 MHz	3.2.46			3	dB
54	Carrier leakage with I/Q	3.2.48			0.3	%

Item No.	Characteristic	Measurement in section	MIN	ACTUAL	MAX	Unit
55	Vector DC Accuracy Error I Error Q	3.2.49			1.5 1.5	% %
56	Modulation frequency response with I/Q $f_{mod} = DC \text{ to } 200\text{MHz}$	3.2.50			3 3	dB dB
57	VSWR of modulation inputs I and Q				1.4 1.4	- -
58	I/Q imbalance Carrier leakage 10 % 50 % I unequal to Q $\pm 1\%$ $\pm 3\%$ $\pm 12\%$ Quadrature offset $\pm 1^\circ$ $\pm 3^\circ$ $\pm 9.9^\circ$	3.2.51				% % % % % % ° ° °
SMHU58-B2 Option GMSK-Coder						
59	Data rate with GMSK $270.833 \text{ kHz} \pm$	3.2.51	-14		+ 14	Hz
60	Modulation phase error with GMSK, F 15 rms peak	3.2.52			1 3	° °
61	Modulation spectrum with GMSK F3, PRBS 215-1 df = 50 kHz df = 100 kHz df = 150 kHz df = 220 kHz df = 300 kHz	3.2.53	- 3.2 - 10.5 - 26 - 41.5 - 58		- 2.6 - 8.5 - 22 - 35.5 - 52	dBc dBc dBc dBc dBc

Item No.	Characteristic	Measurement in section	MIN	ACTUAL	MAX	Unit
SMHU58-B3 Option DECT Coder						
62	Data rate with DECT 1152 kHz \pm	3.2.54	-57		+ 57	Hz
63	Residual FM with DECT , F 15 peak	3.2.55			12	kHz _s
64	Modulation spectrum with DECT, F5, PRBS 2 ¹⁵ -1 df = 200 kHz df = 400 kHz df = 700 kHz df = 1080 kHz df = 1500 kHz	3.2.56	- 2.0 - 6.2 - 22.5 - 33.3 - 59		- 1.4 - 5.2 - 18.5 - 27.3 - 53	dBc dBc dBc dBc dBc
SMHU58-B4 Option ADC-Coder						
65	Data rate with ADC 48.6 kHz \pm Data rate with JDC 42 kHz \pm	3.2.57	- 2.5 - 2.1		+ 2.5 + 2.1	Hz Hz
66	Residual FM with ADC 0000 data AM Φ M	3.2.58			1.5 0.015	% _s rad _s
67	Modulation spectrum with ADC, F 3, PRBS 2 ¹⁵ -1 df = 7 kHz df = 10.7 kHz df = 12.2 kHz df = 13.6 kHz df = 15.6 kHz df = 17 kHz df = 19 kHz Modulation spectrum with JDC, F 6, PRBS 2 ¹⁵ -1 df = 5.3 kHz df = 8.8 kHz df = 10.5 kHz df = 12.2 kHz df = 14.3 kHz df = 15.8 kHz df = 18 kHz	3.2.59	- 0.3 - 1.7 - 3.7 - 7.1 - 19 - 0.3 - 1.7 - 4.1 - 7.2 - 15.6		+ 0.3 - 0.7 - 2.3 - 5.1 - 13 - 20 - 40 + 0.3 - 0.7 - 2.7 - 5.2 - 11.6 - 20 - 40	dBc dBc dBc dBc dBc dBc dBc dBc dBc dBc dBc dBc dBc dBc

Item No.	Characteristic	Measurement in section	MIN	ACTUAL	MAX	Unit
Option SMHU58-B5 CT-Coder						
68	Data rate with CT 384 kHz \pm	3.2.61	-20		+ 20	Hz
69	Residual FM with CT 00000 data AM Φ M	3.2.62			1.5 0.015	% _s rad _s
70	Modulation spectrum with CT, F 2, PRBS 2 ¹⁵ -1 df = 48 kHz df = 80 kHz df = 96 kHz df = 110 kHz df = 131 kHz df = 144 kHz df = 165 kHz	3.2.63	-0.3 -1.7 -3.7 -7 -14.5		0.3 -0.7 -2.3 -5 -11.5 -18 -40	dBc dBc dBc dBc dBc dBc dBc